

# **User Manual**

## **8K/10K/12K INVERTER / CHARGER**

# Table Of Contents

<b>ABOUT THIS MANUAL .....</b>	<b>1</b>
Purpose.....	1
Scope .....	1
<b>SAFETY INSTRUCTIONS.....</b>	<b>1</b>
<b>INTRODUCTION .....</b>	<b>2</b>
Features.....	2
Basic System Architecture .....	2
Product Overview.....	3
<b>INSTALLATION .....</b>	<b>4</b>
Unpacking and Inspection.....	4
Preparation .....	4
Mounting the Unit.....	4
Battery Connection .....	5
AC Input/Output Connection.....	7
PV Connection .....	8
Final Assembly.....	10
Communication Options.....	11
BMS Communication .....	11
<b>OPERATION.....</b>	<b>12</b>
Power ON/OFF .....	12
Operation and Display Panel .....	12
LCD Display Icons .....	13
LCD Setting.....	15
Display Setting .....	21
Operating Mode Description .....	29
Battery Equalization Description.....	30
Fault Reference Code .....	32
Warning Indicator.....	33
<b>CLEARANCE AND MAINTENANCE FOR ANTI-DUST KIT .....</b>	<b>34</b>
Overview .....	34
Clearance and Maintenance.....	34
<b>SPECIFICATIONS .....</b>	<b>35</b>
Table 1 Line Mode Specifications .....	35
Table 2 Inverter Mode Specifications.....	36
Table 3 Charge Mode Specifications .....	37
Table 4 General Specifications .....	37
<b>TROUBLE SHOOTING .....</b>	<b>38</b>
<b>Appendix I: BMS Communication Installation.....</b>	<b>39</b>
<b>Appendix II: The Wi-Fi Operation Guide.....</b>	<b>46</b>

# ABOUT THIS MANUAL

## Purpose

This manual describes the assembly, installation, operation and troubleshooting of this unit. Please read this manual carefully before installations and operations. Keep this manual for future reference.

## Scope

This manual provides safety and installation guidelines as well as information on tools and wiring.

# SAFETY INSTRUCTIONS



**WARNING: This chapter contains important safety and operating instructions. Read and keep this manual for future reference.**

1. Before using the unit, read all instructions and cautionary markings on the unit, the batteries and all appropriate sections of this manual.
2. **CAUTION** --To reduce risk of injury, charge only deep-cycle lead acid type rechargeable batteries. If any other types of batteries are used, follow the manufacturer's instructions carefully.
3. Do not disassemble the unit. Take it to a qualified service center when service or repair is required. Incorrect re-assembly may result in a risk of electric shock or fire.
4. To reduce risk of electric shock, disconnect all wirings before attempting any maintenance or cleaning. Turning off the unit will not reduce this risk.
5. **CAUTION** – Only qualified personnel can install this device with battery.
6. **NEVER** charge a frozen battery.
7. For optimum operation of this inverter/charger, please follow required spec to select appropriate cable size. It's very important to correctly operate this inverter/charger.
8. Be very cautious when working with metal tools on or around batteries. A potential risk exists to drop a tool to spark or short circuit batteries or other electrical parts and could cause an explosion.
9. Please strictly follow installation procedure when you want to disconnect AC or DC terminals. Please refer to INSTALLATION section of this manual for the details.
10. One piece of 150A fuse is provided as over-current protection for the battery supply.
11. GROUNDING INSTRUCTIONS -This inverter/charger should be connected to a permanent grounded wiring system. Be sure to comply with local requirements and regulation to install this inverter.
12. NEVER cause AC output and DC input short circuited. Do NOT connect to the mains when DC input short circuits.
13. **Warning!!** Only qualified service persons are able to service this device. If errors still persist after following troubleshooting table, please send this inverter/charger back to local dealer or service center for maintenance.
14. **WARNING:** Because this inverter is non-isolated, only three types of PV modules are acceptable: single crystalline, poly crystalline with class A-rated and CIGS modules. To avoid any malfunction, do not connect any PV modules with possible current leakage to the inverter. For example, grounded PV modules will cause current leakage to the inverter. When using CIGS modules, please be sure NO grounding.
15. **CAUTION:** It's requested to use PV junction box with surge protection. Otherwise, it will cause damage on inverter when lightning occurs on PV modules.

# INTRODUCTION

This is a multi-function inverter/charger, combining functions of inverter, solar charger and battery charger to offer uninterruptible power support with portable size. Its comprehensive LCD display offers user-configurable and easy-accessible button operation such as battery charging current, AC/solar charger priority, and acceptable input voltage based on different applications.

## Features

- Pure sine wave inverter
- Wide PV input range
- Built-in BMS communication port
- Built-in anti-dust kit
- Inverter running without battery
- Configurable input voltage range for home appliances and personal computers via LCD setting
- Configurable battery charging current based on applications via LCD setting
- Configurable AC/Solar Charger priority via LCD setting
- Compatible to mains voltage or generator power
- Overload/ Over temperature/ short circuit protection
- Smart battery charger design for optimized battery performance

## Basic System Architecture

The following illustration shows basic application for this inverter/charger. It also includes following devices to have a complete running system:

- Generator or Utility.
- PV modules

Consult with your system integrator for other possible system architectures depending on your requirements.

This inverter can power all kinds of appliances in home or office environment, including motor-type appliances such as tube light, fan, refrigerator and air conditioner.

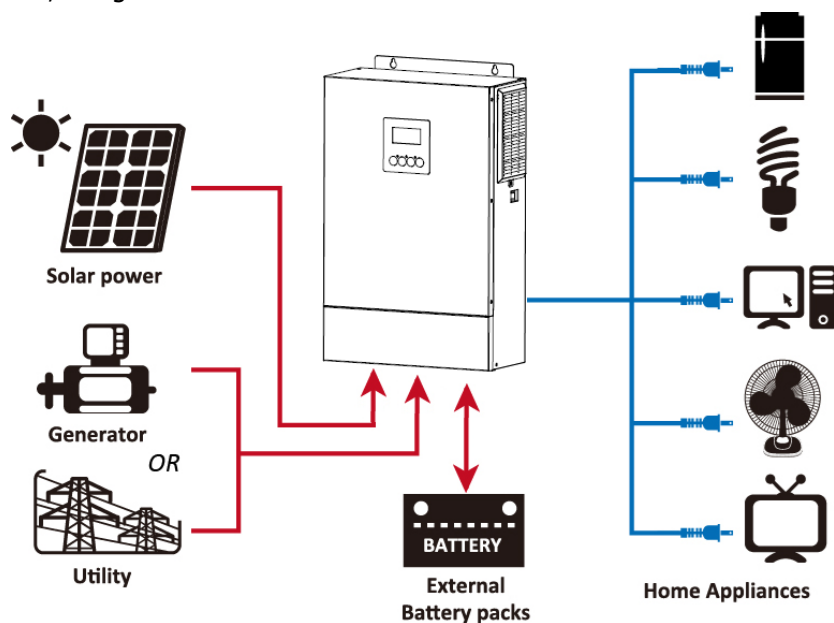
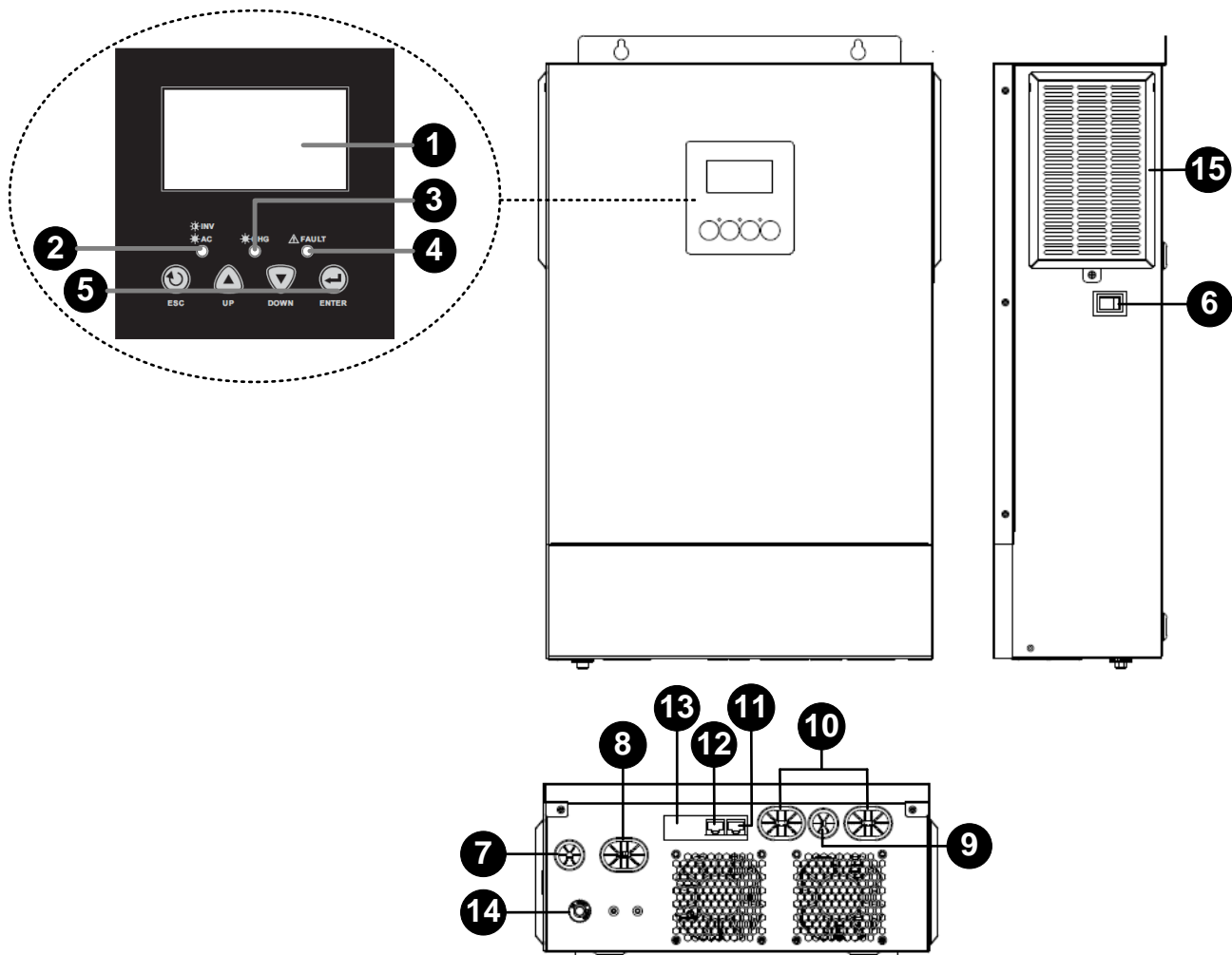

Figure 1 Solar Power System

# Product Overview



1. LCD display
2. Status indicator
3. Charging indicator
4. Fault indicator
5. Function keys
6. Power on/off switch
7. AC input
8. AC output
9. PV input
10. Battery input
11. RS-232 communication port
12. BMS communication port
13. Internal WiFi
14. Input circuit breaker
15. Anti-dust filter

# INSTALLATION

## Unpacking and Inspection

Before installation, please inspect the unit. Be sure that nothing inside the package is damaged. You should have received the following items inside of package:

- The unit x 1
- User manual x 1
- Communication cable x 1
- DC Fuse x 2

## Preparation

Before connecting all wirings, please take off bottom cover by removing two screws as shown below.

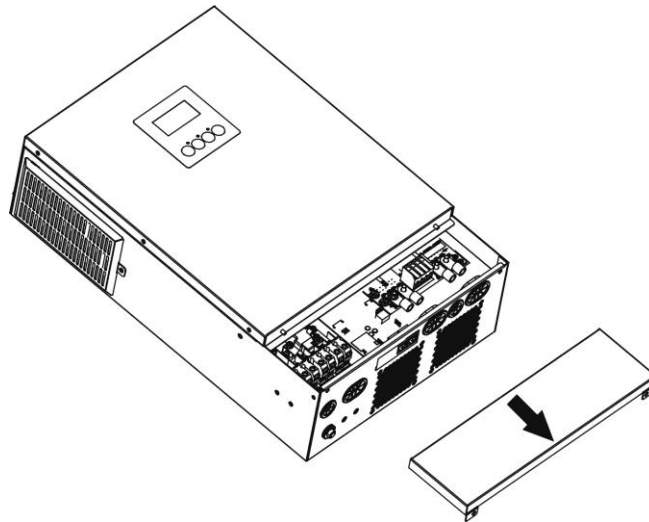

## Mounting the Unit

Consider the following points before selecting where to install:

- Do not mount the inverter on flammable construction materials.
- Mount on a solid surface
- Install this inverter at eye level in order to allow the LCD display to be read at all times.
- For proper air circulation to dissipate heat, allow a clearance of approx. 20 cm to the side and approx. 50 cm above and below the unit.
- The ambient temperature should be between 0°C and 55°C to ensure optimal operation.
- The recommended installation position is to be adhered to the wall vertically.
- Be sure to keep other objects and surfaces as shown in the diagram to guarantee sufficient heat dissipation and to have enough space for removing wires.

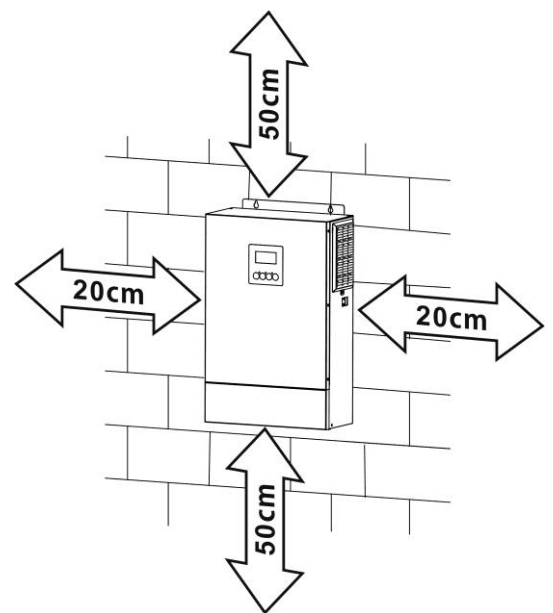

**SUITABLE FOR MOUNTING ON CONCRETE OR OTHER NON-COMBUSTIBLE SURFACE ONLY.**

Drill three holes in the marked location and then install the unit by screwing three screws. It's recommended to use M4 or M5 screws.

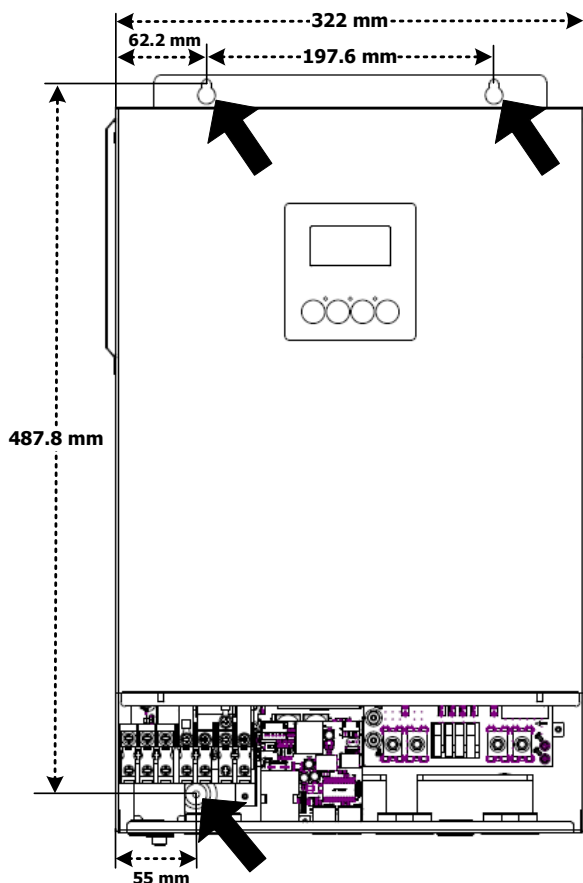

## Battery Connection

**This model can be operated without battery connection. Connect to battery if necessary.**

**CAUTION:** For safety operation and regulation compliance, it's requested to install a separate DC over-current protector or disconnect device between battery and inverter. It may not be requested to have a disconnect device in some applications, however, it's still requested to have over-current protection installed. Please refer to typical amperage in below table as required fuse or breaker size.

**WARNING!** All wiring must be performed by a qualified personnel.

**WARNING!** It's very important for system safety and efficient operation to use appropriate cable for battery connection. To reduce risk of injury, please use the proper recommended cable as below.

### Ring Terminal:

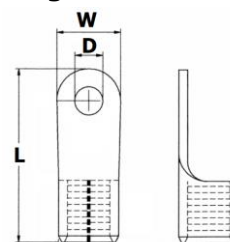

### Recommended battery cable size:

Model	Typical Amperage	Wire Size	Cable (mm <sup>2</sup> )	Dimensions for Ring Terminal			Torque value (max)
				W (mm)	D (mm)	L (mm)	
8K	182.2A	2 x 4AWG	25	12.2	5.3	33.2	3 Nm
10K/ 12K	230A	2 x 2AWG	38	13.2	6.4	37.6	

Please follow below steps to implement battery connection:

1. Assemble battery ring terminals based on recommended battery cable and terminal size.

- This unit supports 48VDC system. Connect all battery packs as below chart. It is recommended to connect at least 250Ah capacity battery.

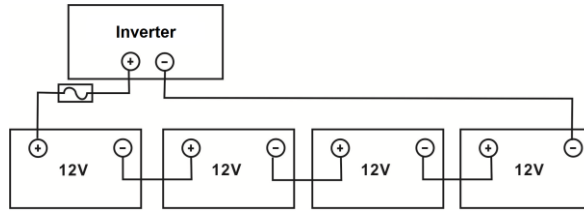

- Remove the nuts on the battery terminals of the inverter.

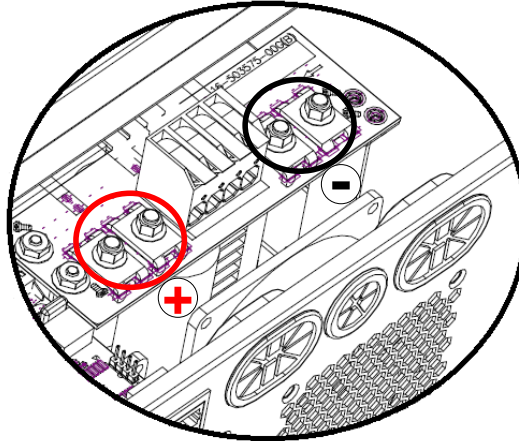

- Insert the ring terminals of battery cable flatly into battery terminals. Then, make sure the nuts are screwed firmly with correct torque.

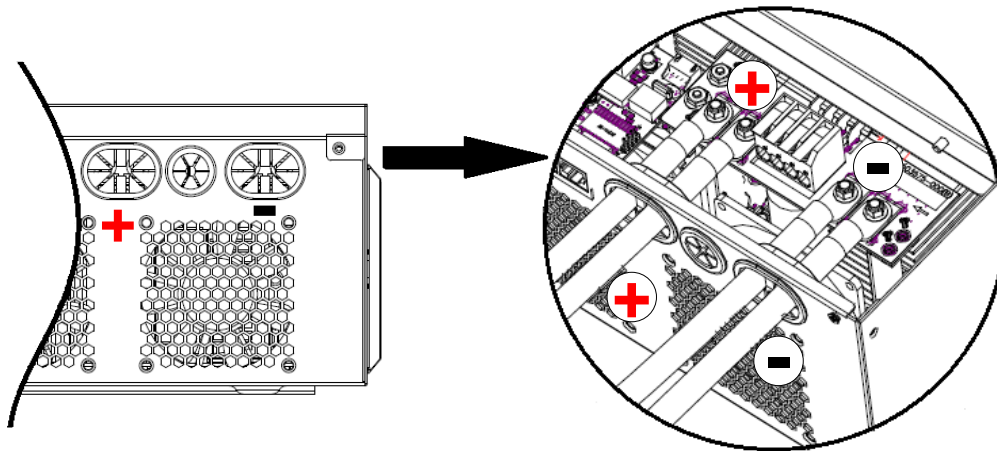

- Connect the other end of the battery cable to the battery (the recommended terminal spec should follow the suggestion of battery manufacturer). Make sure polarity at both the battery and the inverter is correctly connected.

	<p><b>WARNING: Shock Hazard</b> Installation must be performed with care due to high battery voltage in series.</p>
	<p><b>CAUTION!!</b> Do not place anything between inverter terminals and the ring terminals. Otherwise, overheating may occur. <b>CAUTION!!</b> Do not apply anti-oxidant substance on the terminals before terminals are securely tightened. <b>CAUTION!!</b> Before making the final DC connection or closing DC breaker/disconnector, be sure positive (+) must be connected to positive (+) and negative (-) must be connected to negative (-).</p>

## AC Input/Output Connection

**CAUTION!!** Before connecting to AC input power source, please install a **separate** AC breaker between inverter and AC input power source. This will ensure the inverter can be securely disconnected during maintenance and fully protected from over current of AC input. The recommended spec of AC breaker is 20A.

**CAUTION!!** There are two terminal blocks with "IN" and "OUT" markings. Please do NOT mis-connect input and output connectors.

**WARNING!** All wiring must be performed by a qualified personnel.

**WARNING!** It's very important for system safety and efficient operation to use appropriate cable for AC input connection. To reduce risk of injury, please use the proper recommended cable size as below.

### Suggested cable requirement for AC wires

Model	Gauge	Cable (mm <sup>2</sup> )	Torque Value
8K/ 10K/ 12K	8 AWG	8	1.4~1.6 Nm

Please follow below steps to implement AC input/output connection:

1. Before making AC input/output connection, be sure to open DC protector or disconnecter first.
2. Remove insulation sleeve 10mm for seven conductors. And shorten phase L and neutral conductor N 3 mm.
3. Insert AC input wires according to polarities indicated on terminal block and tighten the terminal screws. Be sure to connect PE protective conductor (⊕) first.

⊕→**Ground (yellow-green)**

L→**LINE (brown or black)**

N→**Neutral (blue)**

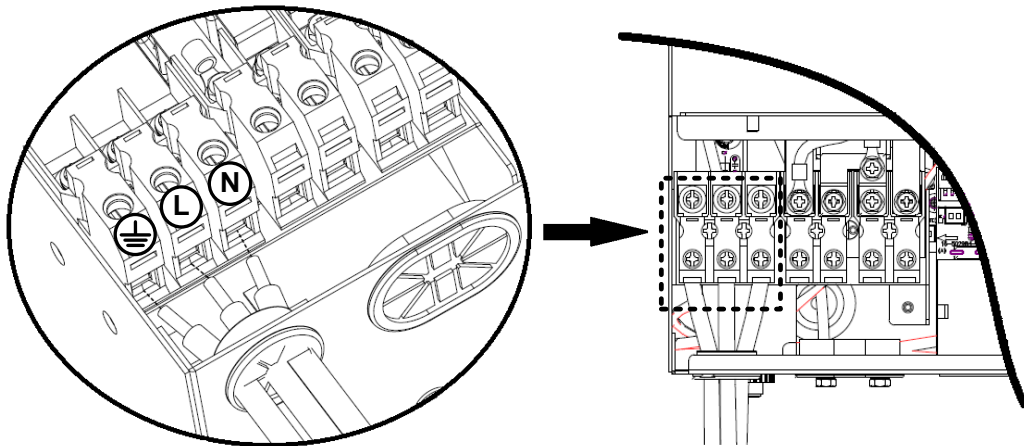

#### **WARNING:**

Be sure that AC power source is disconnected before attempting to hardwire it to the unit.

4. This inverter is equipped with dual-output. There are four terminals (L1/N1, L2/N2) available on output port. It's set up through LCD program or monitoring software to turn on and off the second output. Refer to "LCD setting" section for the details.

Insert AC output wires according to polarities indicated on terminal block and tighten terminal screws. Be sure to connect PE protective conductor (⊕) first.

⊕→**Ground (yellow-green)**

L1→**LINE (brown or black)**

N1→**Neutral (blue)**

L2→**LINE (brown or black)**

N2→**Neutral (blue)**

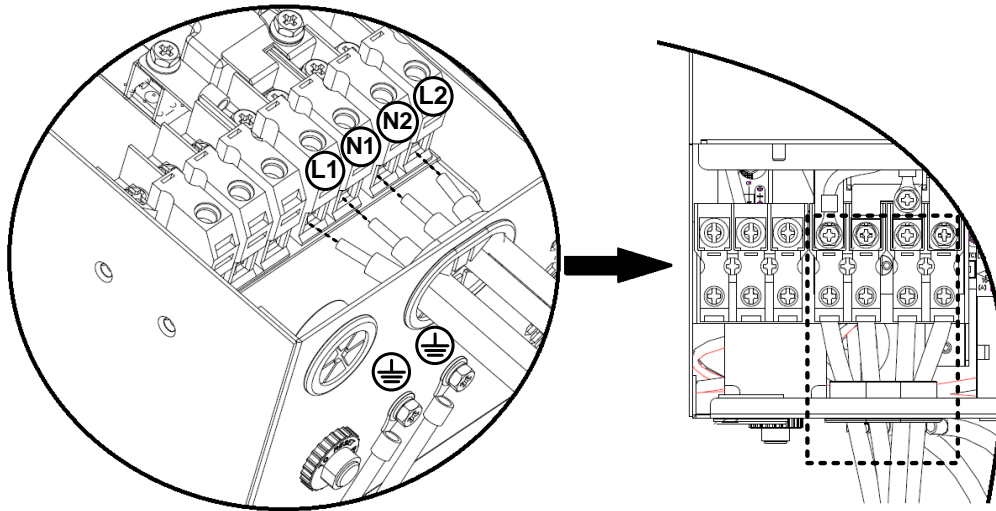

5. Make sure the wires are securely connected.

**CAUTION:** Appliances such as air conditioner are required at least 2~3 minutes to restart because it's required to have enough time to balance refrigerant gas inside of circuits. If a power shortage occurs and recovers in a short time, it will cause damage to your connected appliances. To prevent this kind of damage, please check manufacturer of air conditioner if it's equipped with time-delay function before installation. Otherwise, this inverter/charger will trig overload fault and cut off output to protect your appliance but sometimes it still causes internal damage to the air conditioner.

## PV Connection

**CAUTION:** Before connecting to PV modules, please install **separately** a DC circuit breaker between inverter and PV modules.

**WARNING!** It's very important for system safety and efficient operation to use appropriate cable for PV module connection. To reduce risk of injury, please use the proper recommended cable size as below.

Wire Size	Cable (mm <sup>2</sup> )
10~12 AWG	4~6

**WARNING:** Because this inverter is non-isolated, only three types of PV modules are acceptable: single crystalline, poly crystalline with class A-rated and CIGS modules.

To avoid any malfunction, do not connect any PV modules with possible current leakage to the inverter. For example, grounded PV modules will cause current leakage to the inverter. When using CIGS modules, please be sure NO grounding.

**CAUTION:** It's requested to use PV junction box with surge protection. Otherwise, it will cause damage on inverter when lightning occurs on PV modules.

Never directly touch the terminals of inverter. It might cause lethal electric shock.

### PV Module Selection:

When selecting proper PV modules, please be sure to consider below parameters:

1. Open circuit Voltage (Voc) of PV modules not exceeds max. PV array open circuit voltage of inverter.
2. Open circuit Voltage (Voc) of PV modules should be higher than min. battery voltage.

INVERTER MODEL	8K	P10K	12K
Max. PV Array Power	6000W x 2	7000W x 2	7500W x 2
Max. PV Array Open Circuit Voltage	500Vdc		
PV Array MPPT Voltage Range	90~450Vdc		
Max. PV input Current	22A x 2		27A x 2

This unit is applied with two strings of PV array. Please make sure that the maximum current load for each string cannot beyond of the max PV input current spec.

Take 600Wp PV module as an example, the recommended configurations are listed as below table.

Solar Panel Spec. (reference) - 600Wp - Vmp: 45.30Vdc - Imp: 13.25A - Voc: 53.50Vdc - Isc: 14.03A	Solar Input 1	Solar Input 2	Q'ty of panels	Total input power
	Min in series: 3pcs, per input, Max. in series: 9pcs, per input			
	3pcs in series	x	3pcs	1800W
	x	3pcs in series	3pcs	1800W
	9pcs in series	x	9pcs	5400W
	9pcs in series	9pcs in series	18pcs	10800W
	5pcs in series, 2 Strings in parallel	5pcs in series, 2 Strings in parallel	20pcs	12000W
	6pcs in series, 2 Strings in parallel (only for 10K/12K)	6pcs in series, 2 Strings in parallel (only for 10K/12K)	24pcs	14400W
	7pcs in series, 2 Strings in parallel (only for 12K)	7pcs in series, 2 Strings in parallel (only for 12K)	28pcs	15000W

Take 660Wp PV module as an example, the recommended configurations are listed as below table.

Solar Panel Spec. (reference) - 660Wp - Vmp: 37.80Vdc - Imp: 17.46A - Voc: 45.60Vdc - Isc: 18.55A	Solar Input 1	Solar Input 2	Q'ty of panels	Total input power
	Min in series: 3pcs, per input Max. in series: 9pcs, per input for 8K model 11pcs, per input for 10K/12K model			
	3pcs in series	x	3pcs	1980W
	x	3pcs in series	3pcs	1980W
	9pcs in series	x	9pcs	5940W
	10pcs in series (only for 10K/12K models)	x	10pcs	6600W
	11pcs in series (only for 12K)	x	11pcs	7260W
	9pcs in series	9pcs in series	18pcs	11880W
	10pcs in series (only for 10K/12K models)	10pcs in series	20pcs	13200W
	11pcs in series (only for 10K/12K models)	11pcs in series	22pcs	14520W

### PV Module Wire Connection

Please follow below steps to implement PV module connection:

1. Remove insulation sleeve 11~13 mm for positive and negative conductors.
2. Suggest to put bootlace ferrules on the end of positive and negative wires with a proper crimping tool.
3. Check correct polarity of wire connection from PV modules and PV input terminals. Connect positive pole (+) of connection wire to positive pole (+) of PV input terminals, and connect negative pole (-) of connection wire to negative pole (-) of PV input terminals. Pull the spring cover upward to loosen the PV terminal block, insert the wire conductors into it, and then press down on the spring cover. Make sure the wires are securely locked on PV terminals.

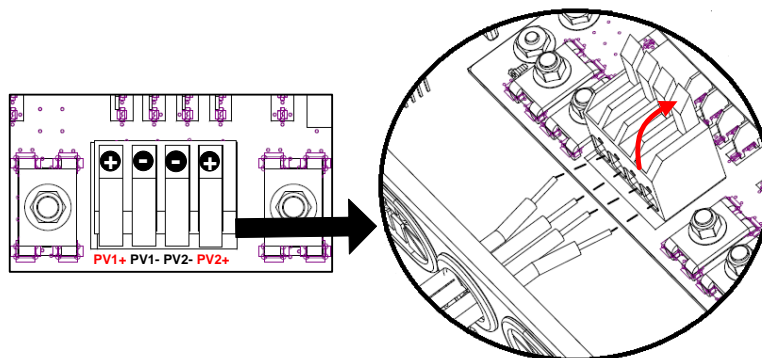
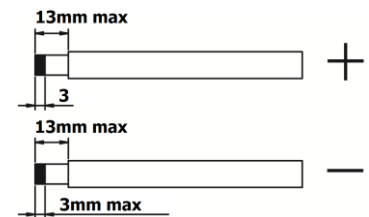

## Final Assembly

After connecting all wirings, please put bottom cover back by screwing screws as shown below.

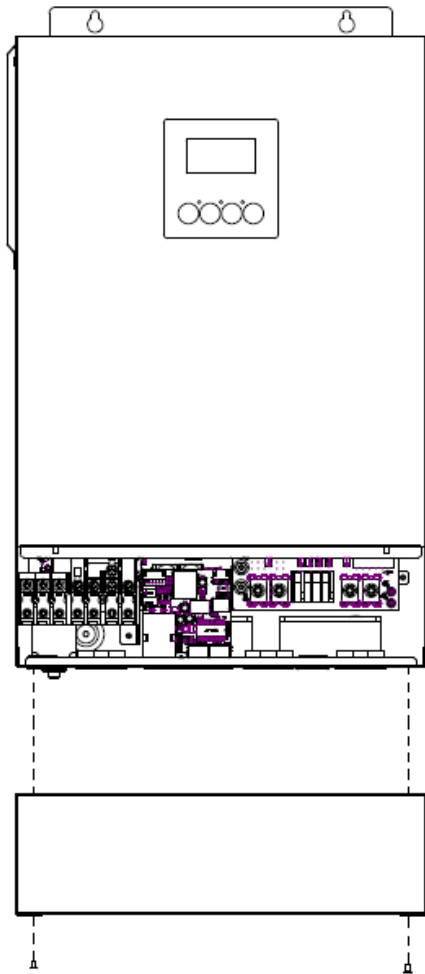

# Communication Options

## Serial Connection

This unit is equipped with a communication port to communicate with a PC with corresponding software. Please use supplied communication cable to connect to inverter and PC. For the detailed software operation, please contact the distributor to obtain software and corresponding user manual downloads.

## Wi-Fi Connection

This unit is equipped with a Wi-Fi transmitter. Wi-Fi transmitter can enable wireless communication between off-grid inverters and monitoring platform. Users can access and control the monitored inverter with downloaded APP. You may find "i.Solar" app from the Apple® Store and Google® Play Store. All data loggers and parameters are saved in iCloud. For quick installation and operation, please refer to Appendix II - The Wi-Fi Operation Guide for details.

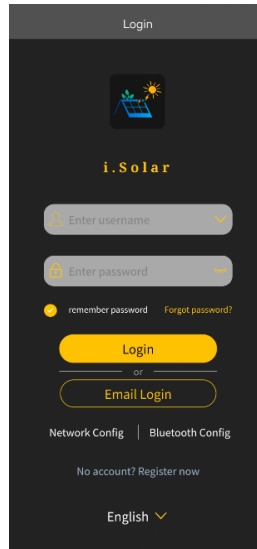

## BMS Communication

If connecting to Lithium-ion battery pack, please check battery provider to get a correct communication cable. Please refer to Appendix I- BMS Communication Installation for details.

# OPERATION

## Power ON/OFF

Side view of unit

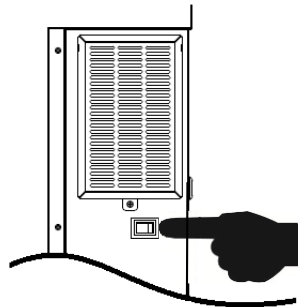

Once the unit has been properly installed and the batteries are connected well, simply press On/Off switch to turn on the unit.

## Operation and Display Panel

The operation and display panel, shown in below chart, is on the front panel of the inverter. It includes three indicators, four function keys and a LCD display, indicating the operating status and input/output power information.

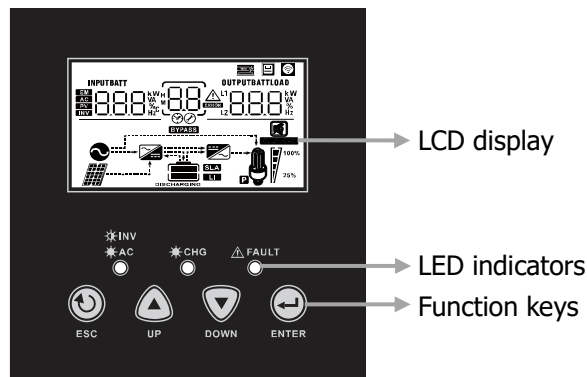

### LED Indicator

LED Indicator		Messages	
✱ INV ✱ AC	Green	Solid On	Output is powered by utility in Line mode.
		Flashing	Output is powered by battery or PV in battery mode.
✱ CHG	Green	Solid On	Battery is fully charged.
		Flashing	Battery is charging.
⚠ FAULT	Red	Solid On	Fault occurs in the inverter.
		Flashing	Warning condition occurs in the inverter.

### Function Keys

Function Key	Description
↻ ESC	To exit setting mode
▲ UP	To go to previous selection
▼ DOWN	To go to next selection
↵ ENTER	To confirm the selection in setting mode or enter setting mode

# LCD Display Icons

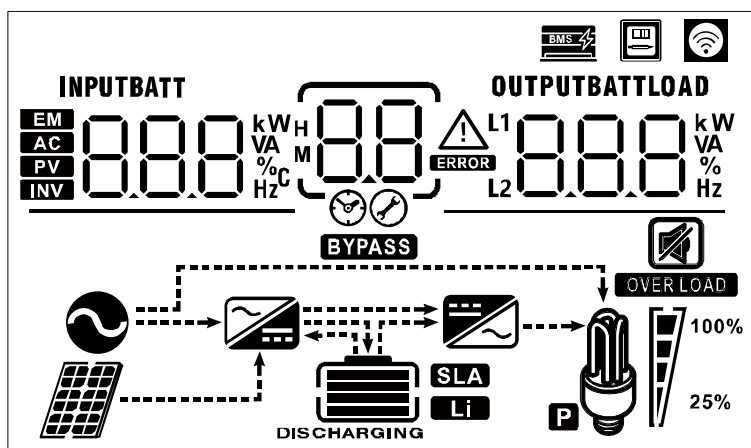

Icon	Function description															
<b>Input Source Information</b>																
<b>AC</b>	Indicates the AC input.															
<b>PV1</b>	Indicates the PV input information of Tracker 1															
<b>PV2</b>	Indicates the PV input information of Tracker 2															
<b>INPUTBATT</b> 	Indicate input voltage, input frequency, PV voltage, PV current, PV power, charger current, charger power, discharger current and battery voltage.															
<b>Configuration Program and Fault Information</b>																
	Indicates the setting programs.															
	Indicates the warning and fault codes. Warning:  flashing with warning code. Fault:  lighting with fault code.															
<b>Output Information</b>																
<b>OUTPUTBATTLOAD</b> 	Indicate output voltage, output frequency, load percent, load in VA, load in Watt and discharging current.															
<b>Battery Information</b>																
	Indicates battery level by 0-24%, 25-49%, 50-74% and 75-100%, charging /discharging status.															
Battery in charging status, it will present battery charging status.																
<table border="1"> <thead> <tr> <th>Status</th> <th>Battery Capacity</th> <th>LCD Display</th> </tr> </thead> <tbody> <tr> <td rowspan="4">Constant Current mode / Constant Voltage mode</td> <td>0-24%</td> <td>4 bars will flash in turns.</td> </tr> <tr> <td>25-49%</td> <td>Bottom bar will be on and the other three bars will flash in turns.</td> </tr> <tr> <td>50-74%</td> <td>Bottom two bars will be on and the other two bars will flash in turns.</td> </tr> <tr> <td>75-100%</td> <td>Bottom three bars will be on and the top bar will flash.</td> </tr> <tr> <td colspan="2">Floating mode. Batteries are fully charged.</td> <td>4 bars will be on.</td> </tr> </tbody> </table>	Status	Battery Capacity	LCD Display	Constant Current mode / Constant Voltage mode	0-24%	4 bars will flash in turns.	25-49%	Bottom bar will be on and the other three bars will flash in turns.	50-74%	Bottom two bars will be on and the other two bars will flash in turns.	75-100%	Bottom three bars will be on and the top bar will flash.	Floating mode. Batteries are fully charged.		4 bars will be on.	
Status	Battery Capacity	LCD Display														
Constant Current mode / Constant Voltage mode	0-24%	4 bars will flash in turns.														
	25-49%	Bottom bar will be on and the other three bars will flash in turns.														
	50-74%	Bottom two bars will be on and the other two bars will flash in turns.														
	75-100%	Bottom three bars will be on and the top bar will flash.														
Floating mode. Batteries are fully charged.		4 bars will be on.														

Battery in discharging status, it will present battery capacity.				
Battery Capacity	0-24%	25-49%	50-74%	75-100%
LCD Display				
<b>Load Information</b>				
	Indicates overload.			
	Indicates the load level by 0-24%, 25-49%, 50-74% and 75-100%.			
	0%~24%	25%~49%	50%~74%	75%~100%
<b>Mode Operation Information</b>				
	Indicates unit connects to the mains.			
	Indicates unit connects to the PV panel.			
	Indicates load is supplied by utility power.			
	Indicates the utility charger circuit is working.			
	Indicates the DC/AC inverter circuit is working.			
<b>Mute Operation</b>				
	Indicates unit alarm is disabled.			
<b>Other Information</b>				
	Indicates BMS communication is established between the inverter and Lithium battery. It flashes while BMS is detected by inverter but communication can't be well established.			
	Indicates the unit is connected to an external energy meter.			
	Indicates the unit is connected with WiFi well if the icon is solid on. It flashes while not be connected.			

## LCD Setting

After pressing and holding ENTER button for 3 seconds, the unit will enter setting mode. Press "UP" or "DOWN" button to select setting programs. And then, press "ENTER" button to confirm the selection or "ESC" button to exit.





### Setting Programs:







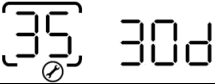

Program	Description	Selectable option	
00	Exit setting mode	Escape 00 ESC	
01	Output source priority: To configure load power source priority	Utility first (default) 01 UTI	Utility will provide power to the loads as first priority. Solar and battery energy will provide power to the loads only when utility power is not available.
		Solar first 01 SOL	Solar energy provides power to the loads as first priority. If solar energy is not sufficient to power all connected loads, Utility energy will supply power to the loads at the same time.
		SBU priority 01 SBU	Solar energy provides power to the loads as first priority. If solar energy is not sufficient to power all connected loads, battery energy will supply power to the loads at the same time. Utility provides power to the loads only when battery voltage drops to either low-level warning voltage or the setting point in program 12.
02	Maximum charging current: To configure total charging current for solar and utility chargers. (Max. charging current = utility charging current + solar charging current)	60A (default) 02 60 <sup>A</sup>	Setting range is from 10A to 150A for 8K model, 10A to 180A for 10K model and from 10A to 200A for 12K model. Increment of each click is 10A.
03	AC input voltage range	Appliances (default) 03 APL	If selected, acceptable AC input voltage range will be within 90-280VAC.
		UPS 03 UPS	If selected, acceptable AC input voltage range will be within 170-280VAC.
05	Battery type	AGM (default) 05 AGM	Flooded 05 FLD

05	Battery type	User-Defined 05 USE	If "User-Defined" is selected, battery charge voltage and low DC cut-off voltage can be set up in program 26, 27 and 29.
		Pylontech battery 05 PYL	If selected, programs of 02, 26, 27 and 29 will be automatically set up. No need for further setting.
		BYD battery 05 BYD	If selected, programs of 02, 26, 27 and 29 will be automatically set up. No need for further setting.
		WECO battery 05 WEC	If selected, programs of 02, 12, 26, 27 and 29 will be auto-configured per battery supplier recommended. No need for further adjustment.
		Soltaro battery 05 SOL	If selected, programs of 02, 26, 27 and 29 will be automatically set up. No need for further setting.
		LIA-protocol compatible battery 05 LIA	Select "LIA" if using Lithium battery compatible to CAN protocol. If selected, programs of 02, 26, 27 and 29 will be automatically set up. No need for further setting.
		LIb-protocol compatible battery 05 LIb	Select "LIb" if using Lithium battery compatible to RS485 protocol. If selected, programs of 02, 26, 27 and 29 will be automatically set up. No need for further setting.
		3 <sup>rd</sup> party Lithium battery 05 LIC	Select "LIC" if using Lithium battery not listed above. If selected, programs of 02, 26, 27 and 29 will be automatically set up. No need for further setting. Please contact the battery supplier for installation procedure.
06	Auto restart when overload occurs	Restart disable (default) 06 LTD	Restart enable 06 LFE
07	Auto restart when over temperature occurs	Restart disable (default) 07 LTD	Restart enable 07 LFE
09	Output frequency	50Hz (default) 09 50 Hz	60Hz 09 60 Hz

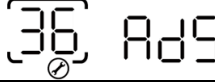
10	Output voltage	220V [10] 220 <sup>v</sup> ⊗	230V (default) [10] 230 <sup>v</sup> ⊗
		240V [10] 240 <sup>v</sup> ⊗	
11	Maximum utility charging current  Note: If setting value in program 02 is smaller than that in program in 11, the inverter will apply charging current from program 02 for utility charger.	40A (default) [11] 40 <sup>A</sup> ⊗	Setting range is 2A, then from 10A to 120A for 8K model, 10A to 150A for 10K model and from 10A to 180A for 12K model. Increment of each click is 10A.
12	Setting voltage point back to utility source when selecting "SBU priority" or "Solar first" in program 01.	Available options:	
		46V (default) [12] 46 <sup>v</sup> ⊗	Setting range is from 44V to 51V. Increment of each click is 1V.
		Available options when any lithium battery type is selected in Program 05.	
13	Setting voltage point back to battery mode when selecting "SBU priority" or "Solar first" in program 01.	Available options: Setting range is FUL and from 48V to 58V. Increment of each click is 1V.	
		Battery fully charged [13] FUL ⊗	54V (default) [13] 54.0 <sup>v</sup> ⊗
		Available option when any lithium battery type is selected in Program 05.	
13	Setting voltage point back to battery mode when selecting "SBU priority" or "Solar first" in program 01.	SOC 10% (default for Lithium) [12] 10 <sup>%</sup> ⊗	If any types of lithium battery is selected in program 05, setting value will change to SOC automatically. Adjustable range is 5% to 95%.
		SOC 80% (default for Lithium) [13] 80 <sup>%</sup> ⊗	If any types of lithium battery is selected in program 05, setting value will change to SOC automatically. Adjustable range is 10% to 100%. Increment of each click is 5%.

16	Charger source priority: To configure charger source priority	If this inverter/charger is working in Line, Standby or Fault mode, charger source can be programmed as below:	
		Solar first [16] C50	Solar energy will charge battery as first priority. Utility will charge battery only when solar energy is not available.
		Solar and Utility (default) [16] 5NU	Solar energy and utility will charge battery at the same time.
		Only Solar [16] 050	Solar energy will be the only charger source no matter utility is available or not.
		If this inverter/charger is working in Battery mode, only solar energy can charge battery. Solar energy will charge battery if it's available and sufficient.	
18	Alarm control	Alarm on (default) [18] 60N	Alarm off [18] 60F
19	Auto return to default display screen	Return to default display screen (default) [19] ESP	If selected, no matter how users switch display screen, it will automatically return to default display screen (Input voltage /output voltage) after no button is pressed for 1 minute.
		Stay at latest screen [19] FEP	If selected, the display screen will stay at latest screen user finally switches.
20	Backlight control	Backlight on (default) [20] LON	Backlight off [20] LOF
22	Beeps while primary source is interrupted	Alarm on (default) [22] AON	Alarm off [22] AOF
23	Overload bypass: When enabled, the unit will transfer to line mode if overload occurs in battery mode.	Bypass disable (default) [23] BYD	Bypass enable [23] BYE
25	Record Fault code	Record enable (default) [25] FEN	Record disable [25] FdS
26	Bulk charging voltage (C.V voltage)	default setting: 56.4V [4] [26] 56.4 <sup>BATT</sup> V	
		If self-defined is selected in program 5, this program can be set up. Setting range is from 48.0V to 61.0V. Increment of each click is 0.1V.	

27	Floating charging voltage	<p>default setting: 54.0V</p>  <p>If self-defined is selected in program 5, this program can be set up. Setting range is from 48.0V to 61.0V. Increment of each click is 0.1V.</p>	
28	<p>Maximum discharging current of battery</p> <p>NOTE: The maximum discharging current of battery can be limited by rated power on battery mode. The unit will discharge with the maximum current without any protection when default "disable" is selected. User can set the value according to the actual battery spec. If discharging current is higher than setting value, battery will stop discharging.</p>	<p>Available options in 8K model: Setting range is disable and from 30A to 180A. Increment of each click is 10A.</p>	
		dIS (default)	dIS (default)
		<p>Available options in 10K/12K models: Setting range is disable and from 30A to 230A. Increment of each click is 10A.</p>	
		dIS (default)	dIS (default)
29	Low DC cut-off voltage or SOC percentage	<p>default setting: 42.0V</p>  <p>If self-defined is selected in program 5, this program can be set up. Setting range is from 42.0V to 52.0V. Increment of each click is 0.1V. Low DC cut-off voltage will be fixed to setting value no matter what percentage of load is connected.</p> <p>Lithium battery default setting: SOC 5%</p>  <p>If any type of lithium battery is selected in program 05, setting value will change to SOC automatically. Adjustable range is 0% to 90%. Increment of each click is 1%.</p>	
30	Battery equalization	Battery equalization	Battery equalization disable (default)
<p>If "Flooded" or "User-Defined" is selected in program 05, this program can be set up.</p>			
31	Battery equalization voltage	<p>default setting: 58.4V</p>  <p>Setting range is from 48.0V to 61.0V. Increment of each click is 0.1V.</p>	
33	Battery equalized time	60min (default)	Setting range is from 5min to 900min. Increment of each click is 5min.

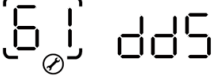
34	Battery equalized timeout	120min (default) 	Setting range is from 5min to 900 min. Increment of each click is 5 min.
35	Equalization interval	30days (default) 	Setting range is from 0 to 90 days. Increment of each click is 1 day.
36	Equalization activated immediately	Enable  Disable (default) 	If equalization function is enabled in program 30, this program can be set up. If "Enable" is selected in this program, it's to activate battery equalization immediately and LCD main page will shows "EQ". If "Disable" is selected, it will cancel equalization function until next activated equalization time arrives based on program 35 setting. At this time, "EQ" will not be shown in LCD main page.
42	AC input detection current *Note: To balance AC input current when an external device (like transformer, energy meter) connected at AC input.	When there is a deviation current caused by external devices connected at AC input, it can be balanced by adjusting the current. Setting range is from 0 to 250. Increment of each click is 1. Nothing shown if unit is not in Line mode. 	150 (default) will show if unit is in Line mode. 
43	Power limit for PV energy in Line Mode *Note: This setting is to prevent excessive energy generated by PV exceeds load demand.	When there is a deviation of load detection caused by external devices connected at AC input, it can be adjusted by this setting. Setting range is from 0W to 250W. Increment of each click is 10W. Nothing shown if unit is not in Line mode. 	30W (default) will show if unit is in Line mode. 
60	Low DC cut off voltage or SOC percentage on second output (L2)	default setting: 42.0V  If User-defined" is selected in program 05, this setting range is from 42.0 to 52.0V. Increment of each click is 0.1V. Low DC cut-off voltage will be fixed to setting value no matter what percentage of load is connected. Lithium battery default setting: SOC 5%  If any types of lithium battery is selected in program 05, this program can be set up. Setting range is from 0% to 90%. Increment of each click is 1%.	
61	Setting discharge time on second output (L2)	Disable (default) 	Setting range is disable and then from 0 min to 990 min. Increment of each click is 5 min. *If the battery discharge time achieves the setting time in Program 61 and the program 60 function is not triggered, the output will be turned off.

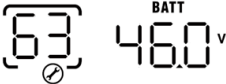
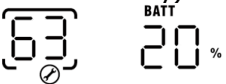
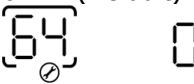
63	Setting voltage point or SOC to restart on the second output (L2)	default setting: 46.0V 	If "User-defined" is selected in program 05, this setting range is from 43.0V to 61.0V. Increment of each click is 0.1V. *If second output is cut off due to setting in program 60, second output (L2) will restart according to setting in program 63.
		SOC: 20% (default for lithium battery) 	If any type of lithium battery is selected in program 05, this parameter value will be displayed in percentage and value setting is based on battery capacity percentage. Setting range is from 5% to 100%. Increment of each click is 5%. *If second output is cut off due to setting in program 60, second output (L2) will restart according to setting in program 63.
64	Setting waiting time to turn on the second output when the inverter is back to Line mode or battery is in charging status	0 min (Default) 	Setting range is from 0 min to 990 min. Increment of each click is 5 min. *If second output is cut off due to setting in program 61, second output (L2) will restart according to setting in program 64.

## Display Setting

The LCD display information will be switched in turns by pressing "UP" or "DOWN" key. The selectable information is switched as following order in listed table.

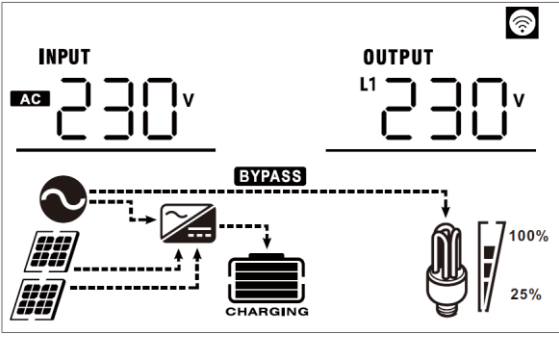
Selectable information	LCD display
Input voltage/Output voltage (Default Display Screen)	<p>Input Voltage=230V, main output voltage=230V</p> 

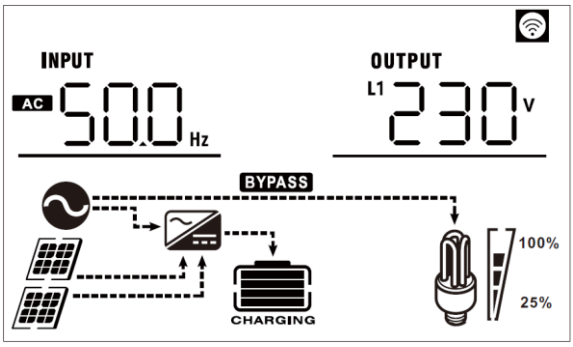
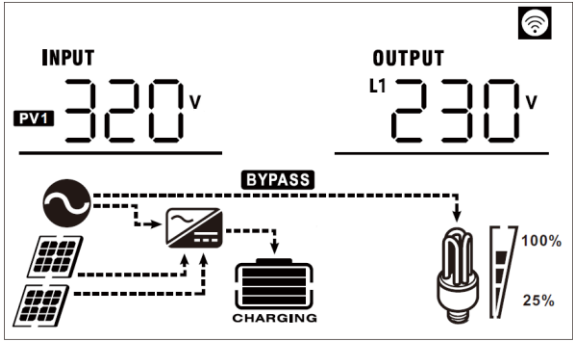
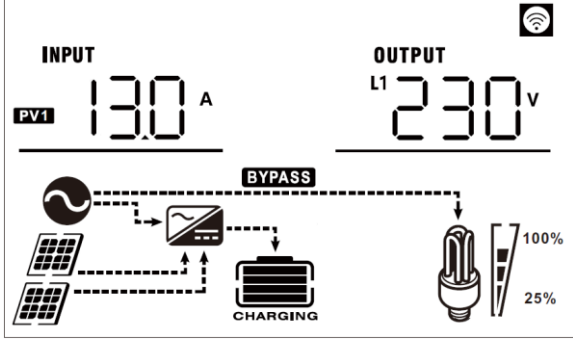
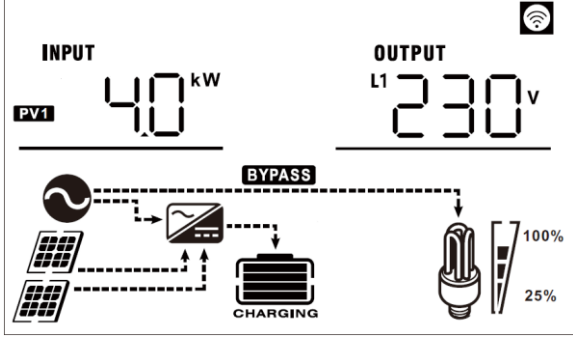
<p>Input frequency</p>	<p>Input frequency=50Hz</p> 
<p>PV1 voltage</p>	<p>PV1 voltage=320V</p> 
<p>PV1 current</p>	<p>PV1 current = 13.0A</p> 
<p>PV1 power</p>	<p>PV1 power = 4.0kW</p> 

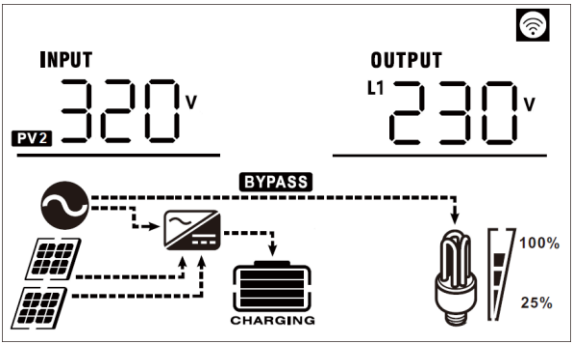
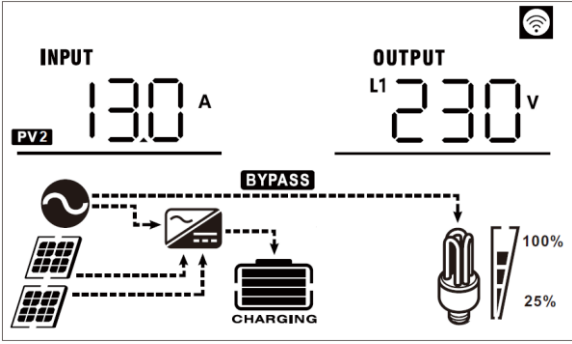
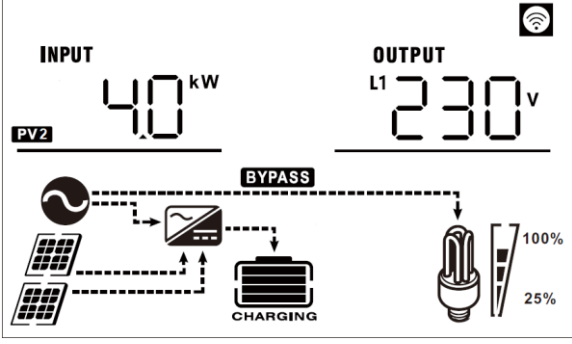
<p>PV2 voltage</p>	<p>PV2 voltage=320V</p>  <p>The display shows an input of 320V and an output of 230V. The schematic diagram shows a power source connected to a device with a BYPASS switch. The device is also connected to a CHARGING unit and a light bulb. The light bulb is shown at 100% and 25% brightness levels.</p>
<p>PV2 current</p>	<p>PV2 current = 13.0A</p>  <p>The display shows an input of 13.0A and an output of 230V. The schematic diagram is identical to the first row, showing a power source, a device with a BYPASS switch, a CHARGING unit, and a light bulb at 100% and 25% brightness.</p>
<p>PV2 power</p>	<p>PV2 power = 4.0kW</p>  <p>The display shows an input of 4.0kW and an output of 230V. The schematic diagram is identical to the previous rows, showing a power source, a device with a BYPASS switch, a CHARGING unit, and a light bulb at 100% and 25% brightness.</p>

Charging current

AC and PV charging current=60A

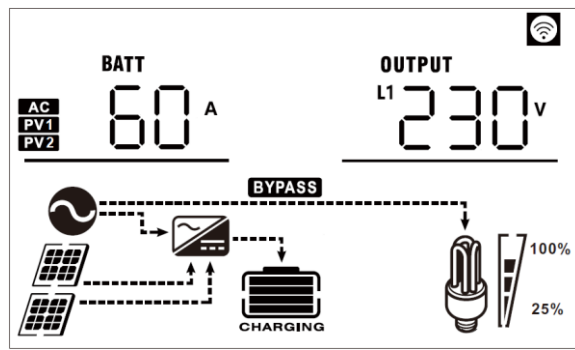

PV charging current=60A

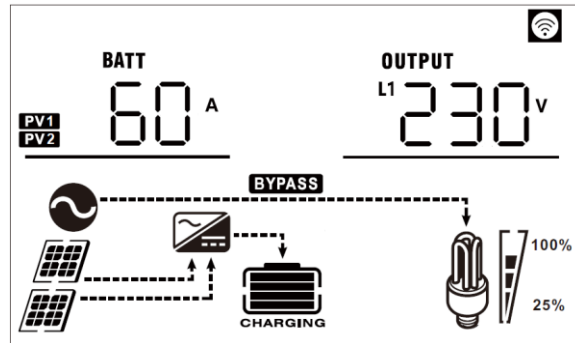

AC charging current=40A

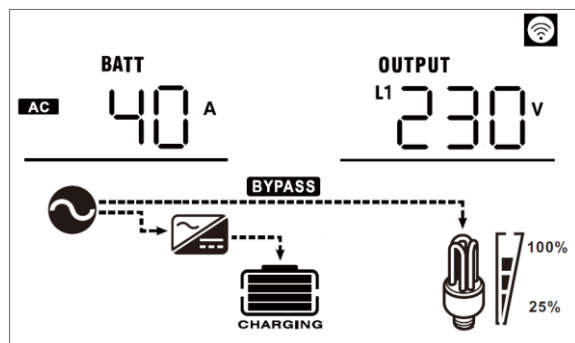

Charging power

AC and PV charging power=1.0kW

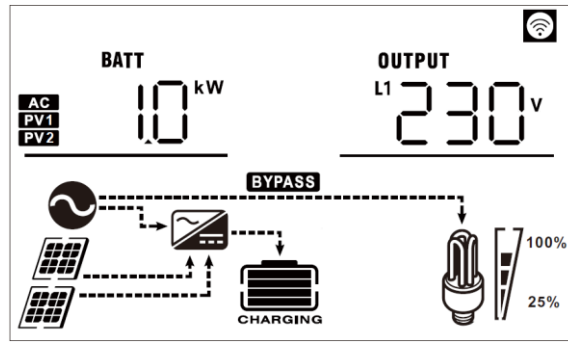

PV charging power=1.0kW

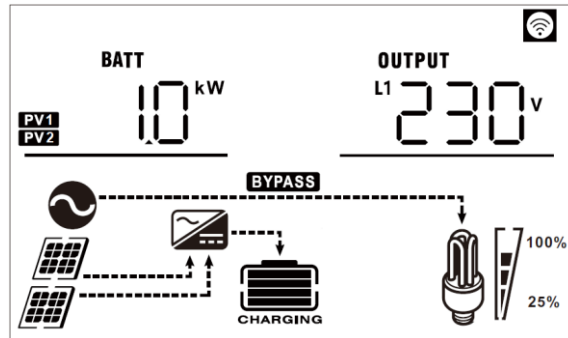

AC charging power=1.0kW

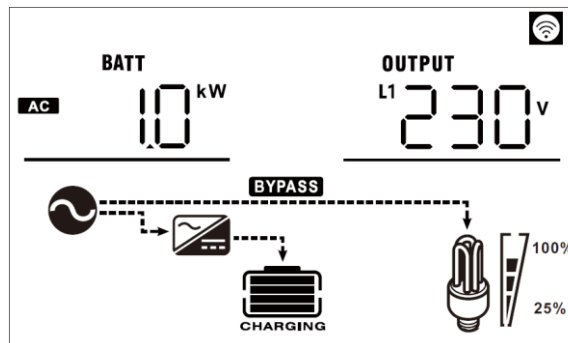

Battery voltage and output voltage

Battery voltage=48.8V, main output voltage=230V

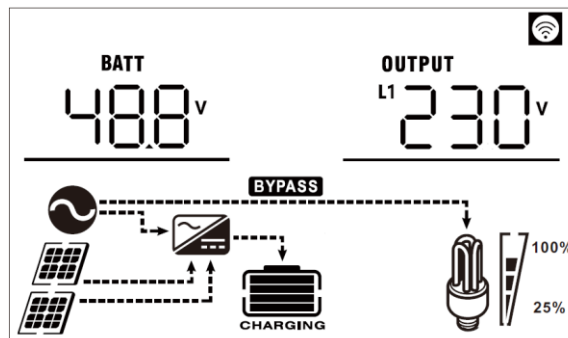

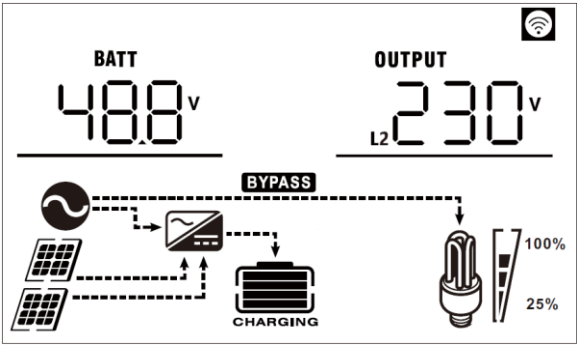
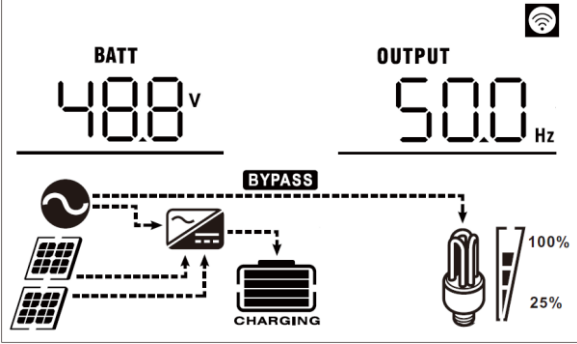
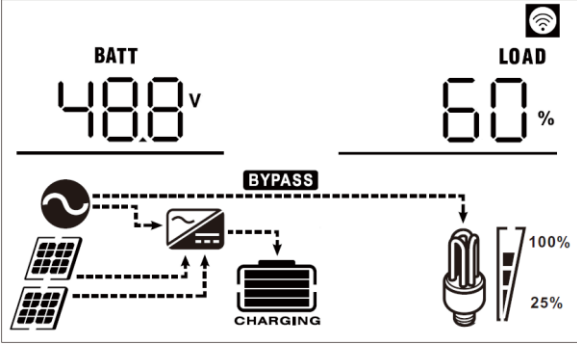
<p>Battery voltage and second output voltage</p>	<p>Battery voltage=48.8V, second output voltage=230V</p> 
<p>Output frequency</p>	<p>Output frequency=50Hz</p> 
<p>Load percentage</p>	<p>Load percent=60%</p> 

Load in VA

When connected load is lower than 1kVA, load in VA will present xxxVA like below chart.

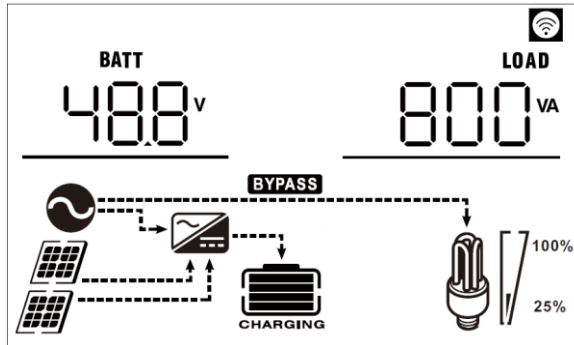

When load is larger than 1kVA ( $\geq 1\text{kVA}$ ), load in VA will present x.xkVA like below chart.

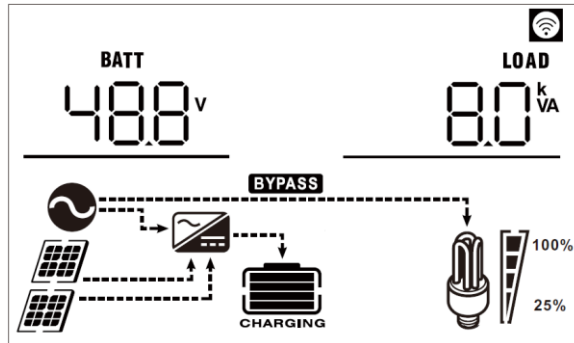

Load in Watt

When load is lower than 1kW, load in W will present xxxW like below chart.

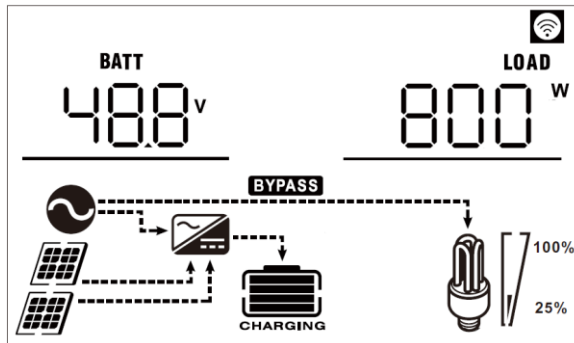



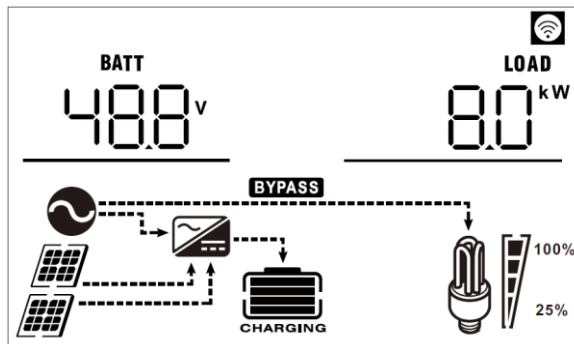

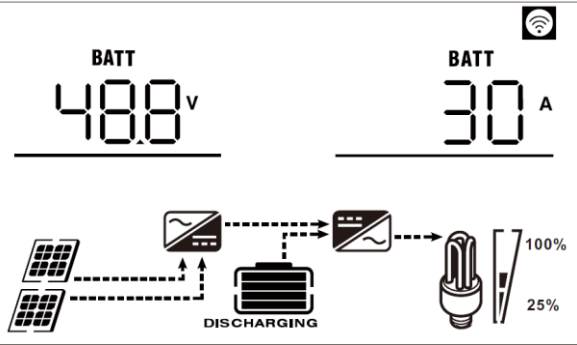
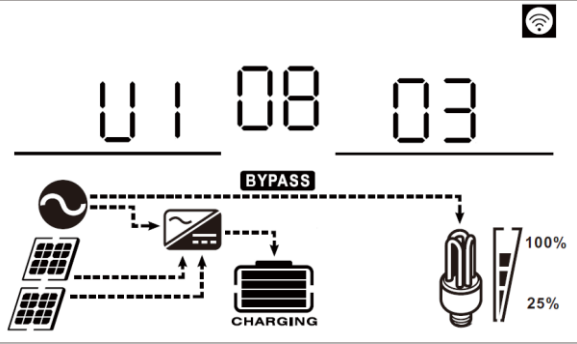
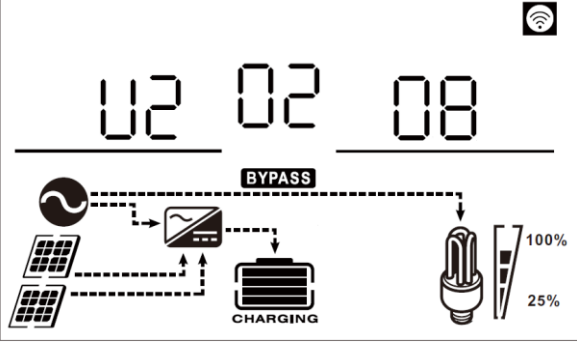
When load is larger than 1kW ( $\geq 1\text{kW}$ ), load in W will present x.xkW like below chart.

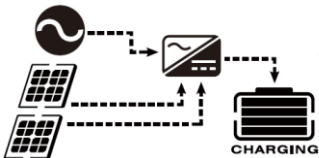

<p>Battery voltage/DC discharging current</p>	<p>Battery voltage=48.8V, discharging current=30A</p> 
<p>Main CPU version checking</p>	<p>Main CPU version 00008.03</p> 
<p>Secondary CPU version checking</p>	<p>Secondary CPU version 00002.08</p> 

# Operating Mode Description

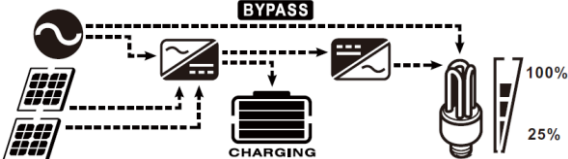
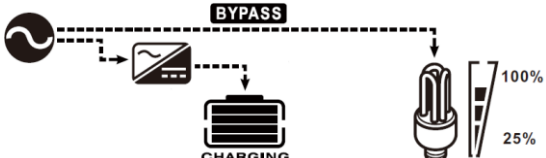
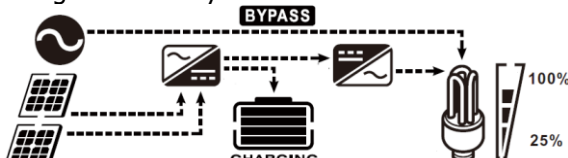
Operation mode	Description	LCD display
<p>Standby mode</p> <p><b>Note:</b></p> <p>*Standby mode: The inverter is not turned on yet but at this time, the inverter can charge battery without AC output.</p>	<p>No output is supplied by the unit but it still can charge batteries.</p>	<p>Charging by utility and PV energy.</p> 
		<p>Charging by utility.</p> 
		<p>Charging by PV energy.</p> 
		<p>No charging.</p> 
<p>Fault mode</p> <p><b>Note:</b></p> <p>*Fault mode: Errors are caused by inside circuit error or external reasons such as over temperature, output short circuited and so on.</p>	<p>PV energy and utility cannot charge batteries.</p>	<p>No charging, no output.</p> 
<p>Line Mode</p>	<p>The unit will provide output power from the mains. It will also charge the battery at line mode.</p>	<p>Charging by utility and PV energy.</p> 
		<p>Charging by utility.</p> 
		<p>If "solar first" is selected as output source priority and solar energy is not sufficient to provide the load, solar energy and the utility will provide the loads and charge the battery at the same time.</p> 

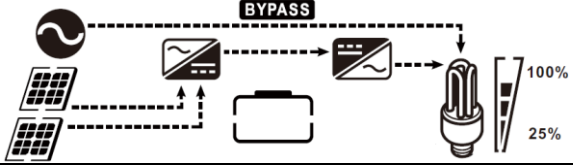
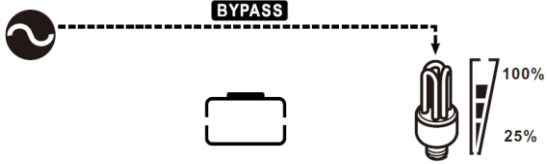
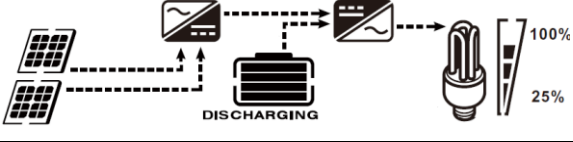
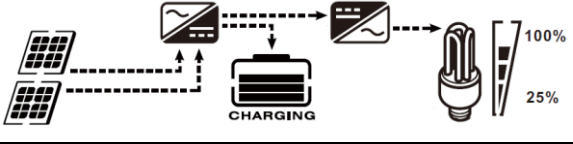
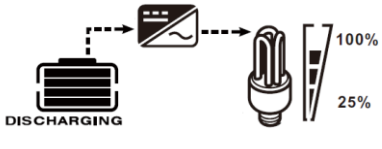
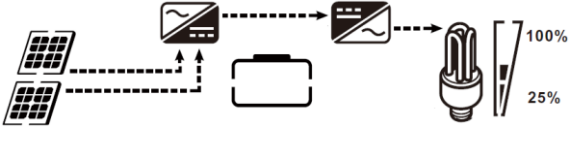
Operation mode	Description	LCD display
Line Mode	The unit will provide output power from the mains. It will also charge the battery at line mode.	<p>If "solar first" is selected as output source priority and battery is not connected, solar energy and the utility will provide the loads.</p> 
		<p>Power from utility.</p> 
Battery Mode	The unit will provide output power from battery and PV power.	<p>Power from battery and PV energy.</p> 
		<p>PV energy will supply power to the loads and charge battery at the same time.</p> 
		<p>Power from battery only.</p> 
		<p>Power from PV energy only.</p> 

## Battery Equalization Description

Equalization function is added into charge controller. It reverses the buildup of negative chemical effects like stratification, a condition where acid concentration is greater at the bottom of the battery than at the top. Equalization also helps to remove sulfate crystals that might have built up on the plates. If left unchecked, this condition, called sulfation, will reduce the overall capacity of the battery. Therefore, it's recommended to equalize battery periodically.

- **How to Apply Equalization Function**

You must enable battery equalization function in monitoring LCD setting program 30 first. Then, you may apply this function in device by either one of following methods:

1. Setting equalization interval in program 35.
2. Active equalization immediately in program 36.

- **When to Equalize**

In float stage, when the setting equalization interval (battery equalization cycle) is arrived, or equalization is active immediately, the controller will start to enter Equalize stage.

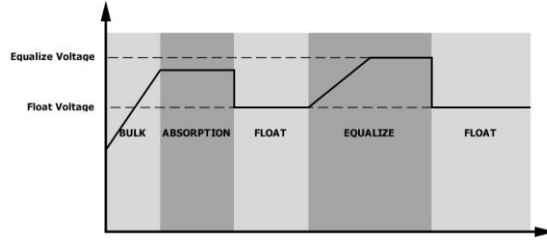

- **Equalize charging time and timeout**



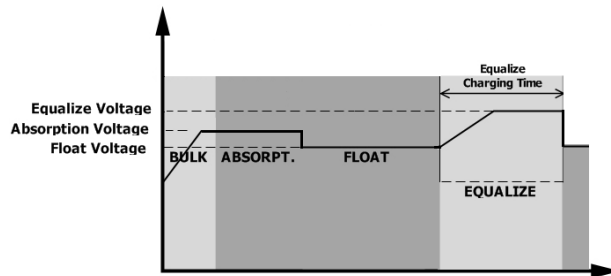



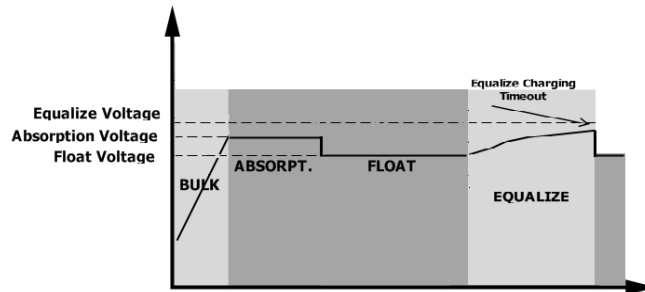









In Equalize stage, the controller will supply power to charge battery as much as possible until battery voltage raises to battery equalization voltage. Then, constant-voltage regulation is applied to maintain battery voltage at the battery equalization voltage. The battery will remain in the Equalize stage until setting battery equalized time is arrived.



However, in Equalize stage, when battery equalized time is expired and battery voltage doesn't rise to battery equalization voltage point, the charge controller will extend the battery equalized time until battery voltage achieves battery equalization voltage. If battery voltage is still lower than battery equalization voltage when battery equalized timeout setting is over, the charge controller will stop equalization and return to float stage.



## Fault Reference Code

Fault Code	Fault Event	Icon on
01	Fan is locked when inverter is off.	
02	Over temperature or NTC is not connected well.	
03	Battery voltage is too high	
04	Battery voltage is too low	
05	Output short circuited or over temperature is detected by internal converter components.	
06	Output voltage is too high.	
07	Overload time out	
08	Bus voltage is too high	
09	Bus soft start failed	
51	Over current or surge	
52	Bus voltage is too low	
53	Inverter soft start failed	
55	Over DC voltage in AC output	
57	Current sensor failed	
58	Output voltage is too low	
59	PV voltage is over limitation	

## Warning Indicator

Warning Code	Warning Event	Audible Alarm	Icon flashing
01	Fan is locked when inverter is on.	Beep three times every second	
02	Over temperature	None	
03	Battery is over-charged	Beep once every second	
04	Low battery	Beep once every second	
07	Overload	Beep once every 0.5 second	
10	Output power derating	Beep twice every 3 seconds	
15	PV energy is low.	Beep twice every 3 seconds	
16	High AC input (>280VAC) during BUS soft start	None	
32	Communication failure between inverter and communication board	None	
E9	Battery equalization	None	
bP	Battery is not connected	None	

# CLEARANCE AND MAINTENANCE FOR ANTI-DUST KIT

## Overview

Every inverter is already installed with anti-dust kit from factory. This kit keeps dust from your inverter and increases product reliability in harsh environment.

## Clearance and Maintenance

**Step 1:** Please loosen the screw in counterclockwise direction on the top or both sides of the inverter.

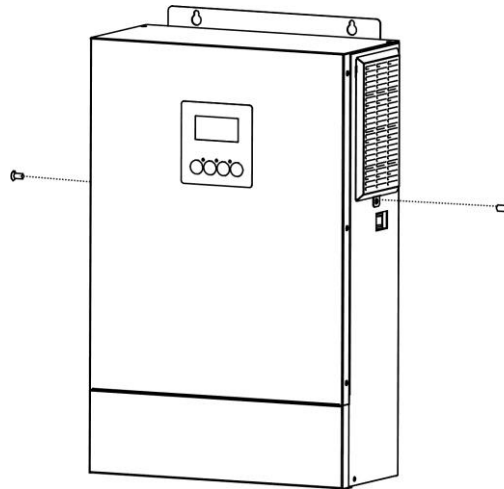

**Step 2:** Then, dustproof case can be removed and take out air filter foam as shown in below chart.

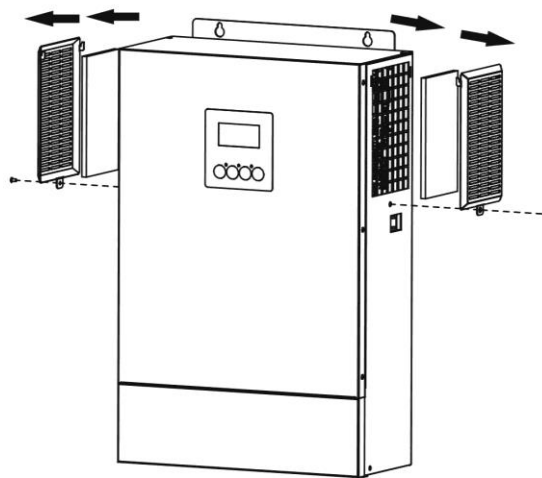

**Step 3:** Clean air filter foam and dustproof case. After clearance, re-assemble the dust-kit back to the inverter.

**NOTICE:** The anti-dust kit should be cleaned from dust every one month.

# SPECIFICATIONS

Table 1 Line Mode Specifications

INVERTER MODEL	8K	10K	12K
<b>Input Voltage Waveform</b>	Sinusoidal (utility or generator)		
<b>Nominal Input Voltage</b>	230Vac		
<b>Low Loss Voltage</b>	170Vac±7V (UPS); 90Vac±7V (Appliances)		
<b>Low Loss Return Voltage</b>	180Vac±7V (UPS); 100Vac±7V (Appliances)		
<b>High Loss Voltage</b>	280Vac±7V		
<b>High Loss Return Voltage</b>	270Vac±7V		
<b>Max AC Input Voltage</b>	300Vac		
<b>Nominal Input Frequency</b>	50Hz / 60Hz (Auto detection)		
<b>Low Loss Frequency</b>	40±1Hz		
<b>Low Loss Return Frequency</b>	42±1Hz		
<b>High Loss Frequency</b>	65±1Hz		
<b>High Loss Return Frequency</b>	63±1Hz		
<b>Output Short Circuit Protection</b>	Circuit Breaker		
<b>Efficiency (Line Mode)</b>	>95% ( Rated R load, battery full charged )		
<b>Transfer Time</b>	10ms typical (UPS); 20ms typical (Appliances)		
<p><b>Output power derating:</b> When AC input voltage drops to 170V, the output power will be derated.</p>	<p>The graph plots Output Power against Input Voltage. The x-axis is labeled 'Input Voltage' and has markers at 90V, 170V, and 280V. The y-axis is labeled 'Output Power' and has markers for '50% Power' and 'Rated Power'. The power is constant at the 'Rated Power' level from 170V up to 280V. At 170V, the power begins to decrease linearly, reaching '50% Power' at 90V. From 90V to 280V, the power remains constant at the 50% level.</p>		

Table 2 Inverter Mode Specifications

<b>INVERTER MODEL</b>	<b>8K</b>	<b>10K</b>	<b>12K</b>
<b>Rated Output Power</b>	8KVA/8KW	10KVA/10KW	12KVA/12KW with PV and battery, 10KVA/10KW with battery only
<b>Output Voltage Waveform</b>	Pure Sine Wave		
<b>Output Voltage Regulation</b>	230Vac±5%		
<b>Output Frequency</b>	50Hz		
<b>Peak Efficiency</b>	93%		
<b>Overload Protection</b>	5s@≥120% load; 30s@103%~120% load		
<b>Surge Capacity</b>	2* rated power for 5 seconds		
<b>Nominal DC Input Voltage</b>	48Vdc		
<b>Cold Start Voltage</b>	46.0Vdc		
<b>Low DC Warning Voltage</b> @ load < 50%	46.0Vdc		
@ load ≥ 50%	44.0Vdc		
<b>Low DC Warning Return Voltage</b> @ load < 50%	47.0Vdc		
@ load ≥ 50%	46.0Vdc		
<b>Low DC Cut-off Voltage</b> @ load < 50%	43.0Vdc		
@ load ≥ 50%	42.0Vdc		
<b>High DC Recovery Voltage</b>	62Vdc		
<b>High DC Cut-off Voltage</b>	63Vdc		
<b>No Load Power Consumption</b>	72W	75W	78W

Table 3 Charge Mode Specifications

Utility Charging Mode			
INVERTER MODEL	8K	10K	12K
Charging Algorithm	3-Step		
AC Charging Current (Max)	120Amp (@V <sub>I/P</sub> =230Vac)	150Amp (@V <sub>I/P</sub> =230Vac)	180Amp (@V <sub>I/P</sub> =230Vac)
Bulk Charging Voltage	Flooded Battery	58.4Vdc	
	AGM / Gel Battery	56.4Vdc	
Floating Charging Voltage	54Vdc		
Charging Curve			
MPPT Solar Charging Mode			
INVERTER MODEL	8K	10K	12K
Max. PV Array Power	12000W (6000W x 2)	14000W (7000W x 2)	15000W (7500W x 2)
Nominal PV Voltage	320Vdc		
Start-up Voltage	150Vdc +/- 10Vdc		
PV Array MPPT Voltage Range	90~450Vdc (Min. 100V without Battery)		
Max. PV Array Open Circuit Voltage	500Vdc		
Max. Input Current	22Amp x 2		27Amp x 2
Max Charging Current (AC charger plus solar charger)	150Amp	180Amp	200Amp

Table 4 General Specifications

INVERTER MODEL	8K	10K	12K
Safety Certification	CE		
Operating Temperature Range	-10°C to 50°C		
Storage temperature	-15°C~ 60°C		
Humidity	5% to 95% Relative Humidity (Non-condensing)		
Dimension (D*W*H), mm	141 x 322 x 497		
Net Weight, kg	14.3	16.3	16.3

# TROUBLE SHOOTING

Problem	LCD/LED/Buzzer	Explanation / Possible cause	What to do
Unit shuts down automatically during startup process.	LCD/LEDs and buzzer will be active for 3 seconds and then complete off.	The battery voltage is too low	1. Re-charge battery. 2. Replace battery.
No response after power on.	No indication.	1. The battery voltage is far too low. 2. Internal fuse tripped.	1. Contact repair center for replacing the fuse. 2. Re-charge battery. 3. Replace battery.
Mains exist but the unit works in battery mode.	Input voltage is displayed as 0 on the LCD and green LED is flashing.	Input protector is tripped	Check if AC breaker is tripped and AC wiring is connected well.
	Green LED is flashing.	Insufficient quality of AC power. (Shore or Generator)	1. Check if AC wires are too thin and/or too long. 2. Check if generator (if applied) is working well or if input voltage range setting is correct. (UPS→Appliance)
	Green LED is flashing.	Set "Solar First" as the priority of output source.	Change output source priority to Utility first.
When the unit is turned on, internal relay is switched on and off repeatedly.	LCD display and LEDs are flashing	Battery is disconnected.	Check if battery wires are connected well.
Buzzer beeps continuously and red LED is on.	Fault code 07	Overload error. The inverter is overload 105% and time is up.	Reduce the connected load by switching off some equipment.
		If PV input voltage is higher than specification, the output power will be derated. At this time, if connected loads is higher than derated output power, it will cause overload.	Reduce the number of PV modules in series or the connected load.
	Fault code 05	Output short circuited.	Check if wiring is connected well and remove abnormal load.
	Fault code 02	Internal temperature of inverter component is over.	Check whether the air flow of the unit is blocked or whether the ambient temperature is too high.
	Fault code 03	Battery is over-charged.	Return to repair center.
		The battery voltage is too high.	Check if spec and quantity of batteries are meet requirements.
	Fault code 01	Fan fault	Replace the fan.
	Fault code 06/58	Output abnormal (Inverter voltage is too low or too high)	1. Reduce the connected load. 2. Return to repair center
	Fault code 08/09/53/57	Internal components failed.	Return to repair center.
	Fault code 51	Over current or surge.	Restart the unit, if the error happens again, please return to repair center.
	Fault code 52	Bus voltage is too low.	
	Fault code 55	Output voltage is unbalanced.	
Fault code 59	PV input voltage is beyond the specification.	Reduce the number of PV modules in series.	

# Appendix I: BMS Communication Installation

## 1. Introduction

If connecting to lithium battery, it is recommended to purchase a custom-made RJ45 communication cable. Please check with your dealer or integrator for details.

This custom-made RJ45 communication cable delivers information and signal between lithium battery and the inverter. These information are listed below:

- Re-configure charging voltage, charging current and battery discharge cut-off voltage according to the lithium battery parameters.
- Have the inverter start or stop charging according to the status of lithium battery.

## 2. Pin Assignment for BMS Communication Port

	Definition
PIN 1	RS232TX
PIN 2	RS232RX
PIN 3	RS485B
PIN 4	NC
PIN 5	RS485A
PIN 6	CANH
PIN 7	CANL
PIN 8	GND

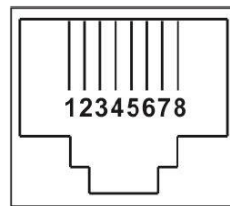

## 3. Lithium Battery Communication Configuration

### LIO-4805/LIO-4810-150A

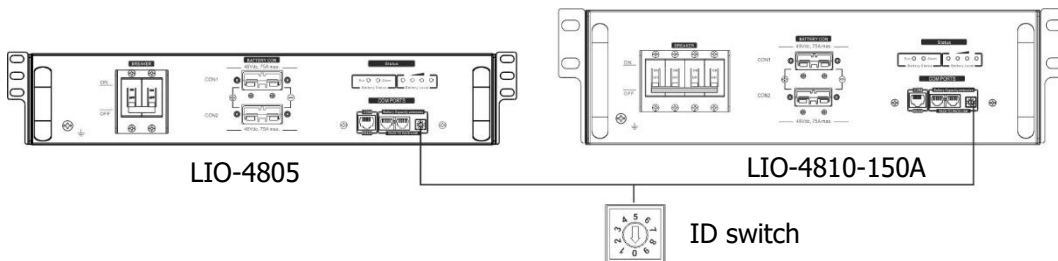

### LIO II-4810

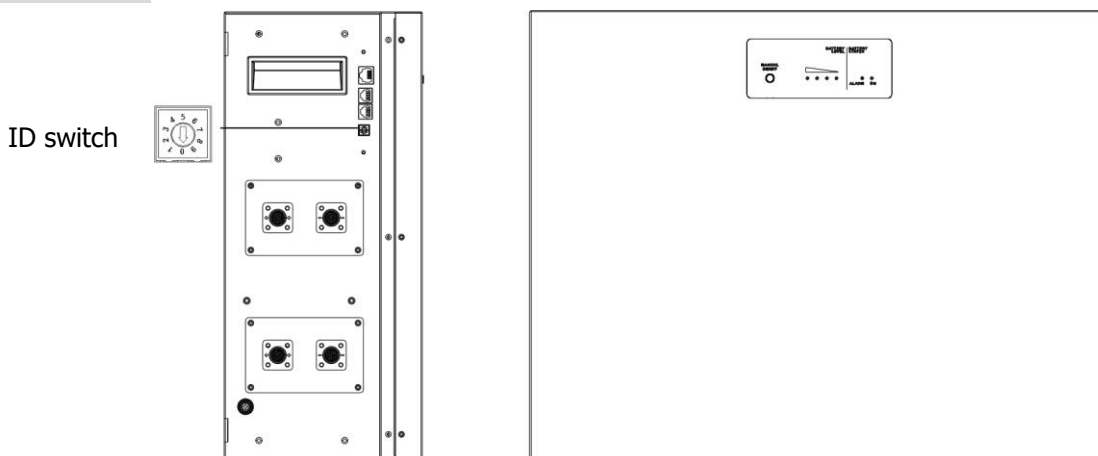

ID Switch indicates the unique ID code for each battery module. It's required to assign an identical ID to each battery module for normal operation. We can set up the ID code for each battery module by rotating the PIN number on the ID switch. From number 0 to 9, the number can be random; no particular order. Maximum 10

battery modules can be operated in parallel.

**PYLONTECH**

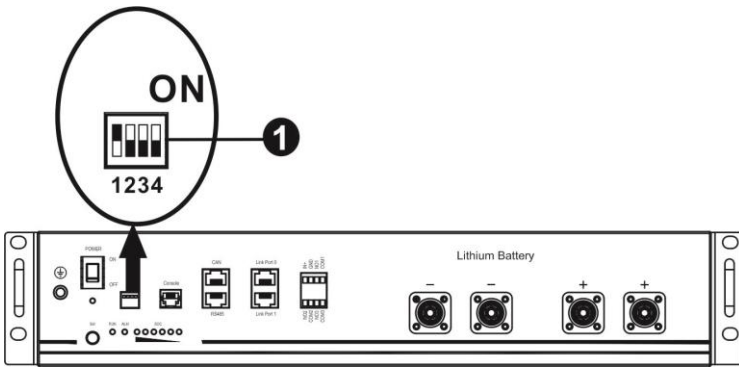

❶ Dip Switch: There are 4 Dip Switches that sets different baud rate and battery group address. If switch position is turned to the "OFF" position, it means "0". If switch position is turned to the "ON" position, it means "1".

Dip 1 is "ON" to represent the baud rate 9600.

Dip 2, 3 and 4 are reserved for battery group address.

Dip switch 2, 3 and 4 on master battery (first battery) are to set up or change the group address.

**NOTE:** "1" is upper position and "0" is bottom position.

Dip 1	Dip 2	Dip 3	Dip 4	Group address
1: RS485 baud rate=9600  <b>Restart to take effect</b>	0	0	0	Single group only. It's required to set up master battery with this setting and slave batteries are unrestricted.
	1	0	0	Multiple group condition. It's required to set up master battery on the first group with this setting and slave batteries are unrestricted.
	0	1	0	Multiple group condition. It's required to set up master battery on the second group with this setting and slave batteries are unrestricted.
	1	1	0	Multiple group condition. It's required to set up master battery on the third group with this setting and slave batteries are unrestricted.
	0	0	1	Multiple group condition. It's required to set up master battery on the fourth group with this setting and slave batteries are unrestricted.
	1	0	1	Multiple group condition. It's required to set up master battery on the fifth group with this setting and slave batteries are unrestricted.

**NOTE:** The maximum groups of lithium battery is 5 and for maximum number for each group, please check with battery manufacturer.

**4. Installation and Operation**

**LIO-4805/LIO-4810-150A/ LIO II-4810**

After ID no. is assigned for each battery module, please set up LCD panel in inverter and install the wiring connection as following steps.

Step 1: Use supplied RJ11 signal cable to connect into the extension port (P1 or P2).

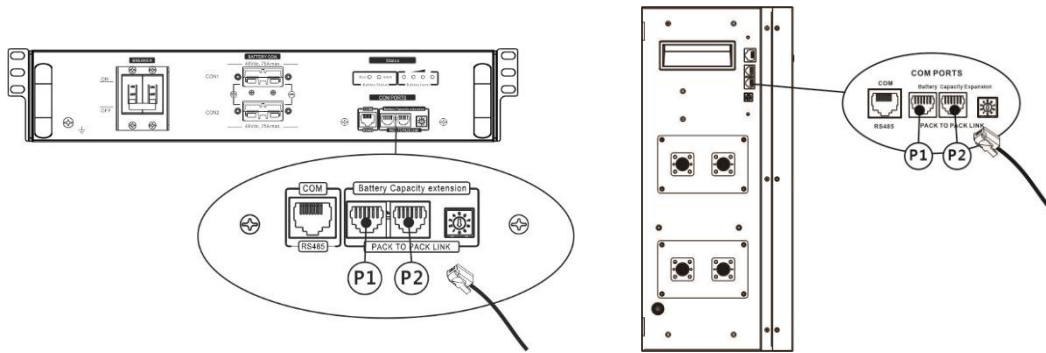

Step 2: Use supplied RJ45 cable (from battery module package) to connect inverter and Lithium battery.

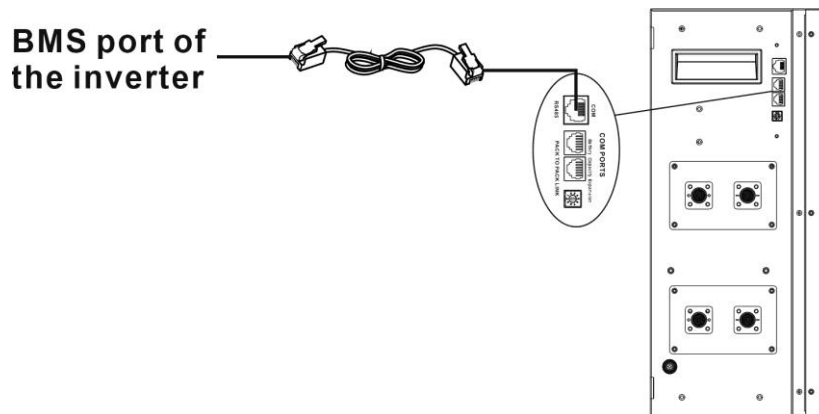
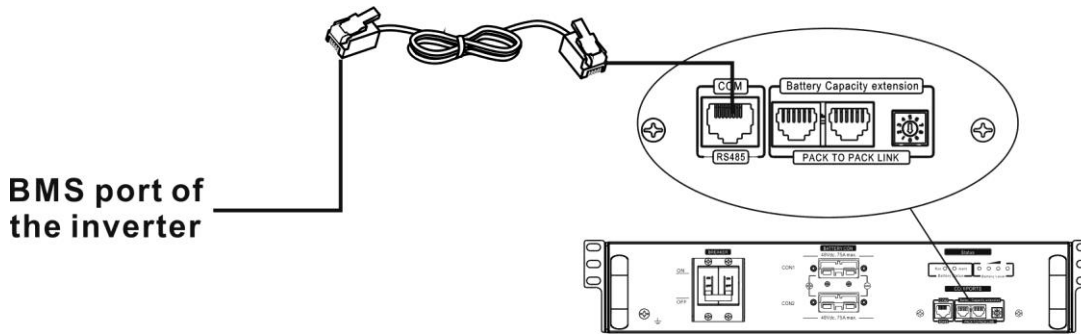

**Note for parallel system:**

1. Only support common battery installation.
2. Use custom-made RJ45 cable to connect any inverter (no need to connect to a specific inverter) and Lithium battery. Simply set this inverter battery type to "LIB" in LCD program 5. Others should be "USE".

Step 3: Turn the breaker switch "ON". Now, the battery module is ready for DC output.

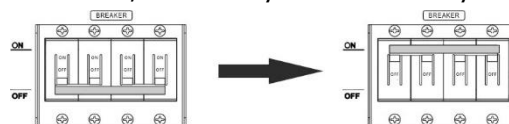

Step 4: Press Power on/off button on battery module for 5 secs, the battery module will start up.

\*If the manual button cannot be approached, just simply turn on the inverter module. The battery module will be automatically turned on.

Step 5. Turn on the inverter.

Step 6. Be sure to select battery type as "LIB" in LCD program 5.

05 LIB



If communication between the inverter and battery is successful, the battery icon on LCD display will flash. Generally speaking, it will take longer than 1 minute to establish communication.

### **PYLONTECH**

After configuration, please install LCD panel with inverter and Lithium battery with the following steps.

Step 1. Use custom-made RJ45 cable to connect inverter and Lithium battery.

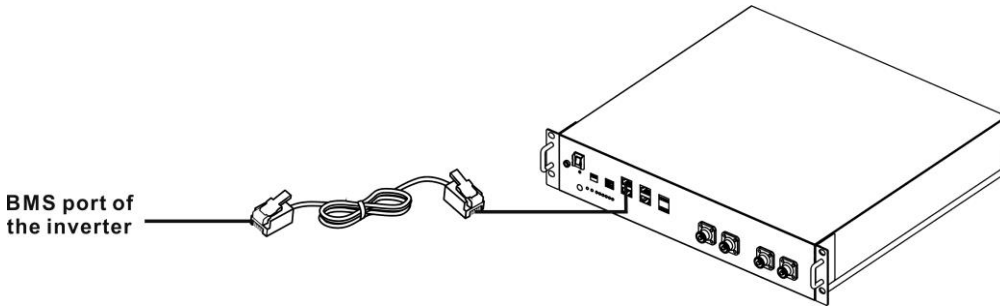

Step 2. Switch on Lithium battery.

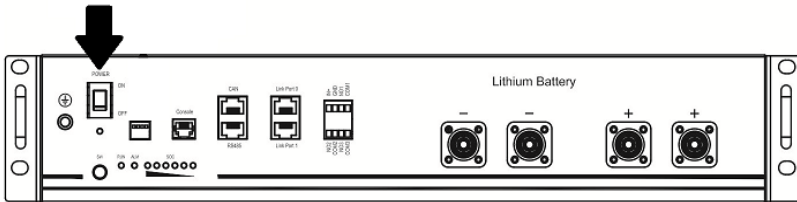

Step 3. Press more than three seconds to start Lithium battery. Output power is ready.

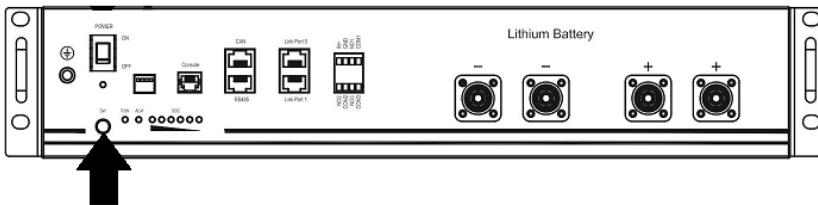

Step 4. Turn on the inverter.

Step 5. Be sure to select battery type as "PYL" in LCD program 5.

05 PYL



If communication between the inverter and battery is successful, the battery icon on LCD display will flash. Generally speaking, it will take longer than 1 minute to establish communication.

## WECO

Step 1. Use a custom-made RJ45 cable to connect inverter and Lithium battery.

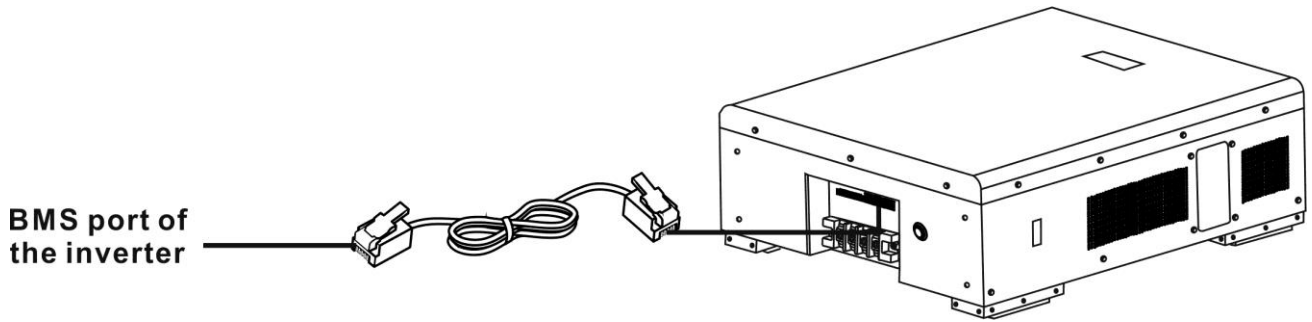

Step 2. Switch on Lithium battery.

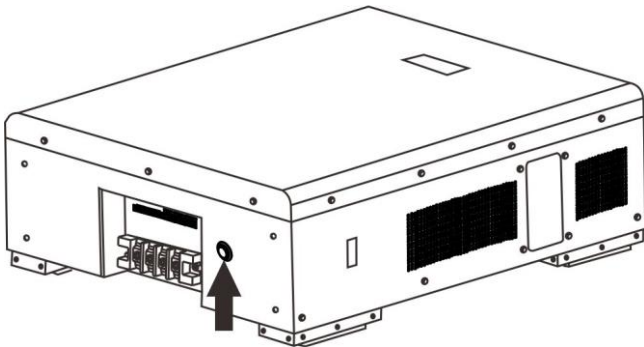

Step 3. Turn on the inverter.

Step 4. Be sure to select battery type as "WEC" in LCD program 5.



If communication between the inverter and battery is successful, the battery icon  on LCD display will "flash". Generally speaking, it will take longer than 1 minute to establish communication.

## SOLTARO

Step 1. Use a custom-made RJ45 cable to connect inverter and Lithium battery.

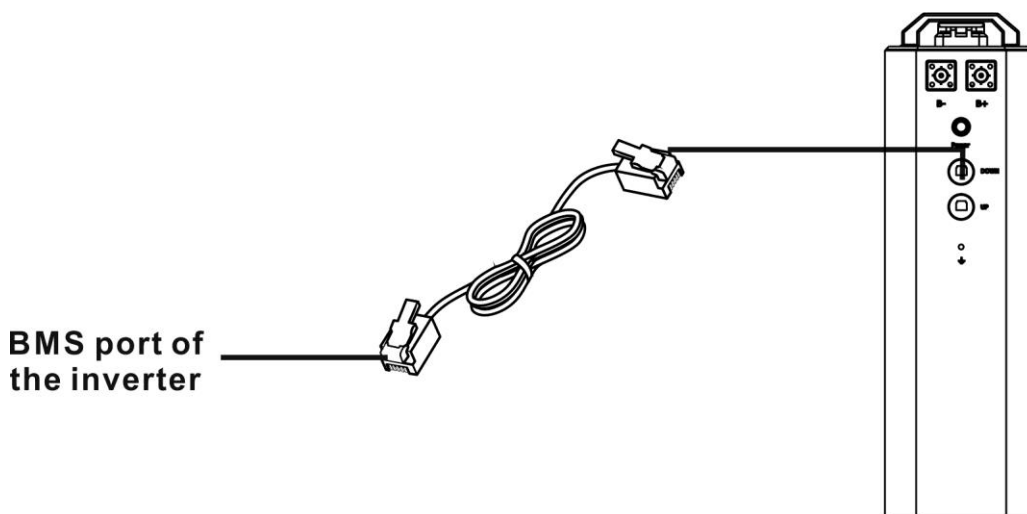

Step 2. Open DC isolator and switch on Lithium battery.

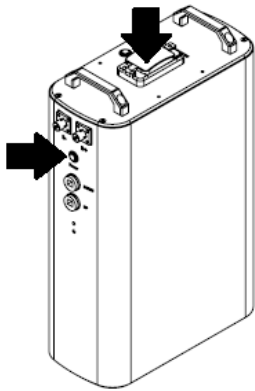

Step 3. Turn on the inverter.

Step 4. Be sure to select battery type as "SOL" in LCD program 5.



If communication between the inverter and battery is successful, the battery icon on LCD display will "flash". Generally speaking, it will take longer than 1 minute to establish communication.

### 5. LCD Display Information

Unit powers on with lithium battery, the LCD will show lithium battery icon **Li**. Once battery BMS communication is successfully established, the LCD of inverter will shown icon .

Press "UP" or "DOWN" key to switch LCD display to check battery voltage information as shown below.

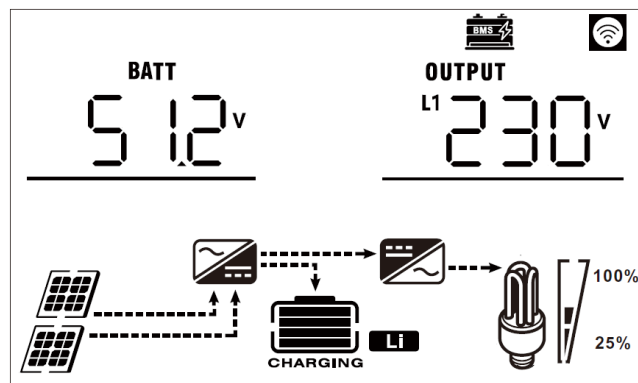





### Active Function

This function is to activate lithium battery automatically while commissioning. After battery wiring and commissioning is successfully, if battery is not detected, the inverter will automatically activate battery if the inverter is powered on.

## 6. Code Reference

Related information code will be displayed on LCD screen. Please check inverter LCD screen for the operation.

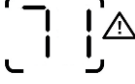
Code	Description
	If battery status is not allowed to charge and discharge after the communication between the inverter and battery is successful, it will show code 60 to stop charging and discharging battery.
	Communication lost (only available when the battery type is setting as any type of lithium-ion battery.) <ul style="list-style-type: none"> <li>• After battery is connected, communication signal is not detected for 3 minutes, buzzer will beep. After 10 minutes, inverter will stop charging and discharging to lithium battery.</li> <li>• Communication lost occurs after the inverter and battery is connected successfully, buzzer beeps immediately.</li> </ul>
	Battery number is changed. It probably is because of communication lost between battery packs. Please check the cables between the batteries.
	If battery status is not allowed to charge after the communication between the inverter and battery is successful, it will show code 69 to stop charging battery.
	If battery status must be charged after the communication between the inverter and battery is successful, it will show code 70 to charge battery.
	If battery status is not allowed to discharge after the communication between the inverter and battery is successful, it will show code 71 to stop discharging battery.

# Appendix II: The Wi-Fi Operation Guide

## 1. Introduction

Wi-Fi module can enable wireless communication between solar inverters and the monitoring platform. Users can remotely monitor and control their inverters easily by i.Solar APP. The App uses the Wi-Fi chip to provide remote monitoring data services, which is beneficial for the daily data monitoring of the inverter, querying the real-time data in the device, sending commands from the device, and operating the device remotely. The app is available for both iOS and Android.

## 2. i.Solar App

### 2-1. Download and install APP

Please find "i.Solar" APP from Apple® store or Google® Play Store. Install this APP in your mobile phone.



Or scan the following QR code with your smart phone and download "i.Solar" APP



Android system



iOS system

### 2-2. Network Setting for Wi-Fi Module

Use the "i.Solar" APP to configure the Wi-Fi module's network via Bluetooth or local Wi-Fi. It's recommended to connect your smart phone and the Wi-Fi module through Bluetooth. This example uses the Android system.

- Turn on the unit.
- Open the Bluetooth settings from your smart phone.
- Open the "i.Solar" APP, select "Bluetooth config" on the login page, press "refresh" search nearby to find the Wi-Fi module named starts with "FC41D\_".
- Click the device name starts to match.
- Once the Wi-Fi module connection is successfully. Enter your router name (STA SSID) and router password (STA Password), click "Start configuration" to check the connection status.

If you check the "Open" box marked in red, you only need to enter the router name (STA SSID), do not need to enter the router password.

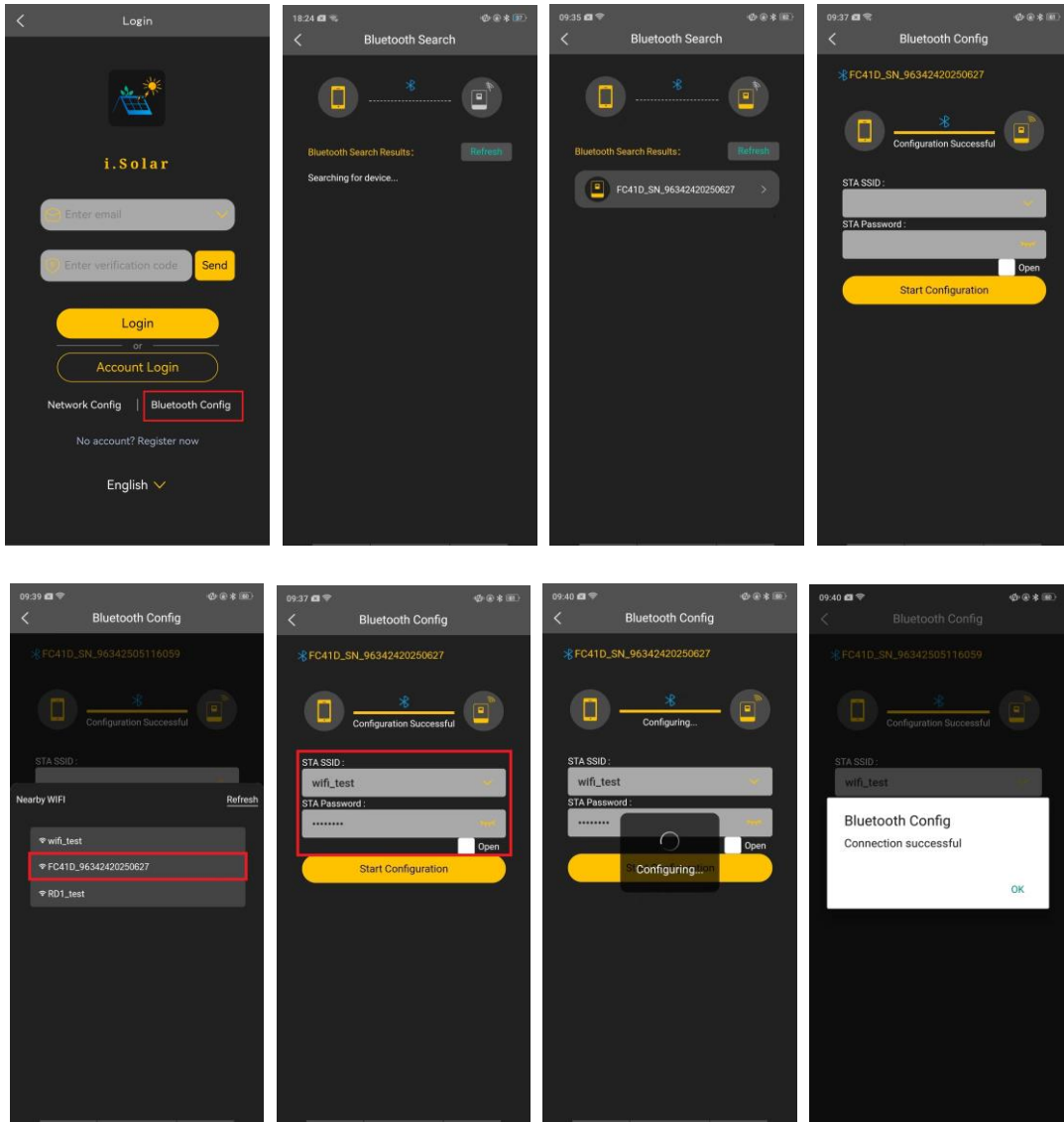

**If you have configured the network through Bluetooth, please skip following steps.**

**Step 1:** Open the Wi-Fi settings from your smart phone.

**Step 2:** Connect your smart phone to the Wi-Fi module. The Wi-Fi named starts with "FC41D\_". The default password for the Wi-Fi module is **12345678**.

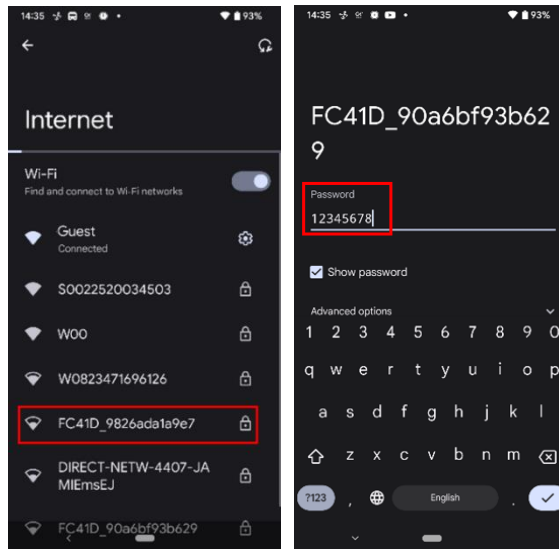

**Step 3:** After the Wi-Fi connection is successful, click the i.Solar App installed on the phone to enter the login page. Then, click the "Network Config" button to enter the Wi-Fi configuration page.

**Step 4:** Enter your router name (STA SSID) and router password (STA Password), then click the "Save" button to complete the setting.

If you check the "Open" box marked in red, you only need to enter the router name (STA SSID), you don't need to enter the router password. Click the "Save" button to complete the setting.

**Step 5:** Enter the Wi-Fi name (AP SSID) and Wi-Fi password (AP Password) of the Wi-Fi card, confirm the password again and click the "Save" button to complete the setting of the Wi-Fi module.

If you check "Open" marked in red, you only need to enter the Wi-Fi name (AP SSID), you don't need to enter the Wi-Fi password and Confirmation. Click the "Save" button to complete the setting.

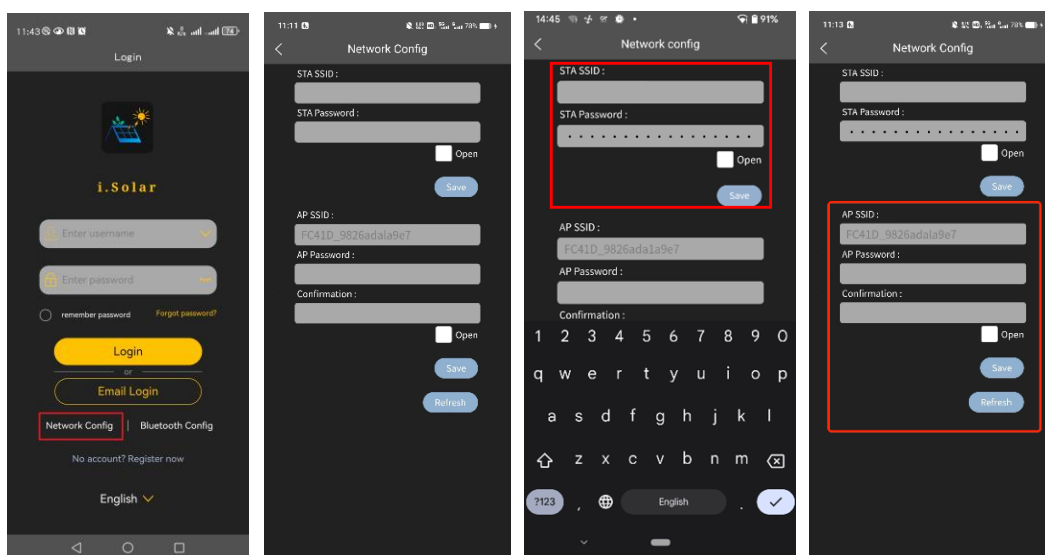

### 2-3. Registration and Login

Enter the login page shown below. Click on "No account? Register now" to enter the registration page. On the registration page, fill the username, nickname, email, verification code and password in sequence, and confirm the password a second time. Then click the "Register" button to complete the user registration.

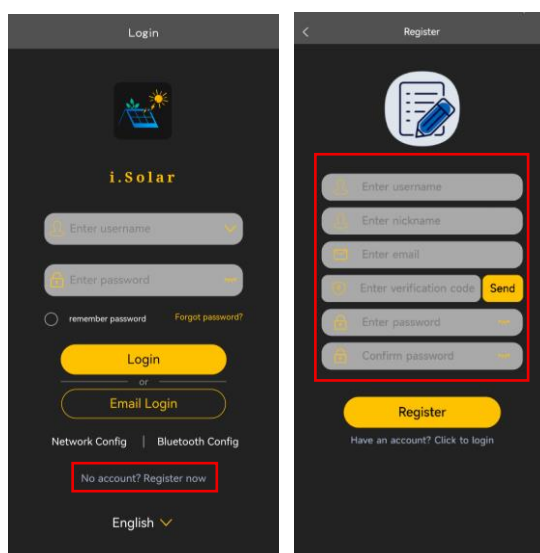

Once registration is complete, users can choose to log in with a username or an email address.

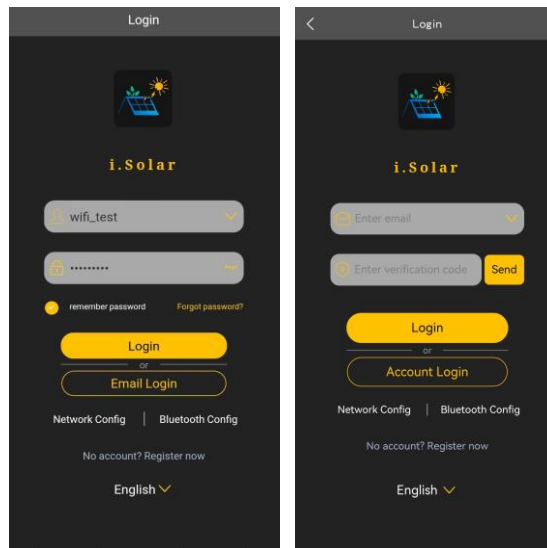

## 2-4. Home Page

Log in to enter the App. The default Home page will appear where you can view the charts (left screenshot). Click the button 'Day', 'Month', and 'Year' to query the power generation data. Click 'Total' to query the annual power generation data.

Tap the icon (located on the top right corner) to enter the page to add, delete or rename the device. Enter the device serial number to add the device.

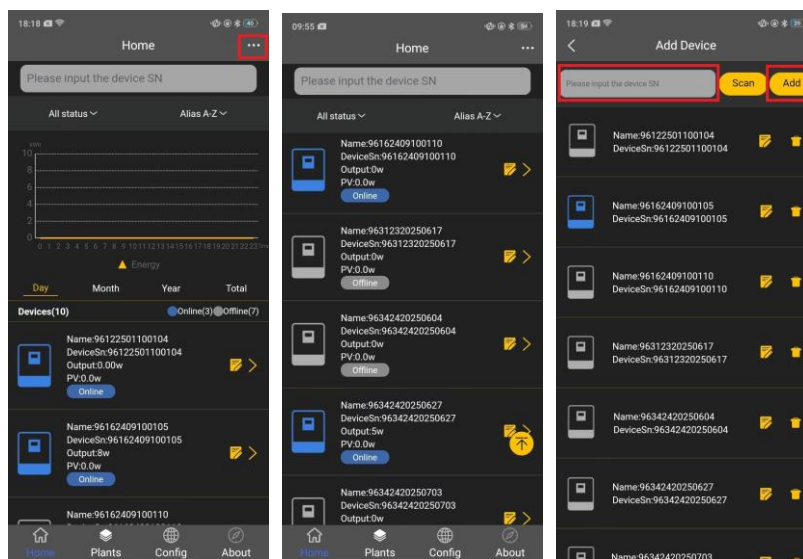

Rename (left screenshot) or delete (right) the devices by pressing the buttons highlighted by the red box.

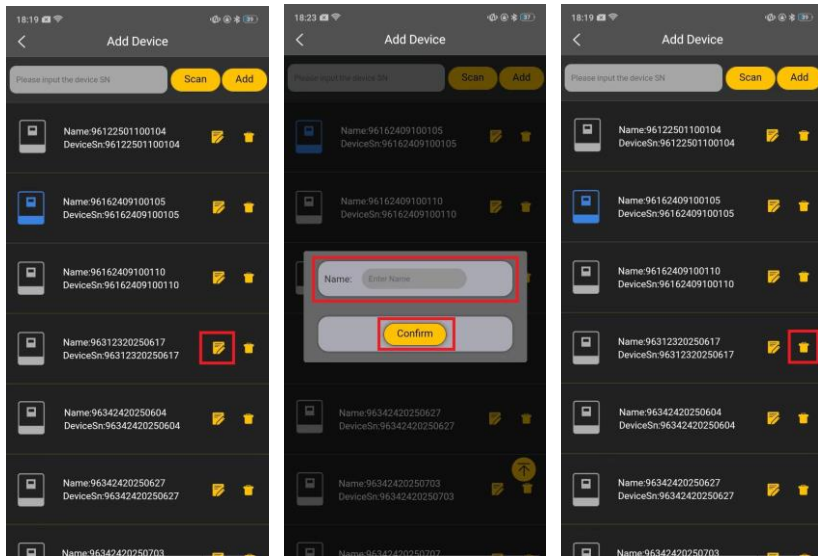

## 2-5. Real-time Data

Press the device name in Home Page to enter the corresponding detailed real-time information page.

'Real-time' displays solar, grid, load, and battery information. Press "Sync" can synchronize the status of the device. Pull down the page see more detailed information.

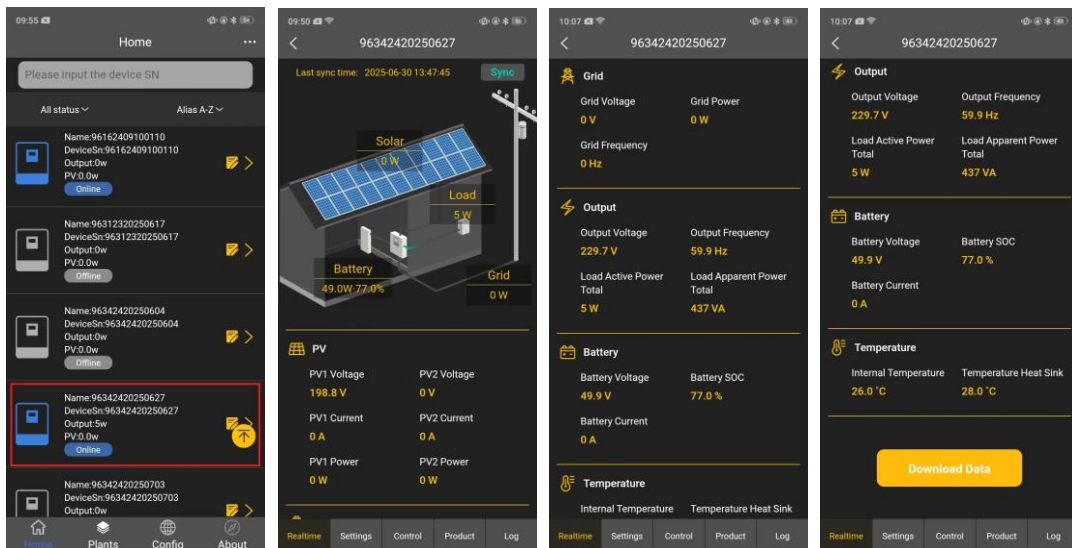

'Settings' displays the setting items. Note that the setting items on this page will be different for different models. Tap on the dropdown icon to select the setting and click the "Apply" button to change the setting.

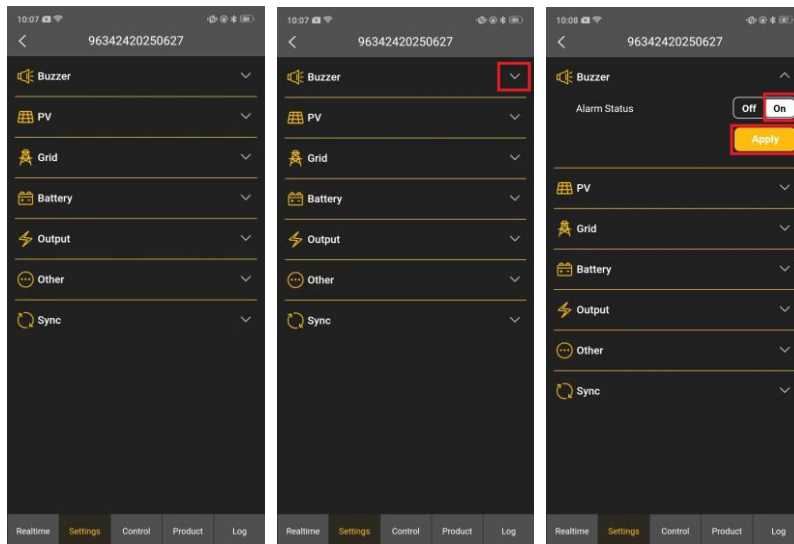

'Control' is reserved. (The control item is not support for all models)

'Product' displays the firmware update, product information, rating information and factory data reset.

**NOTE**: The inverter output should be turned off during updating.

'Log' displays the data log, power generation log and event log.

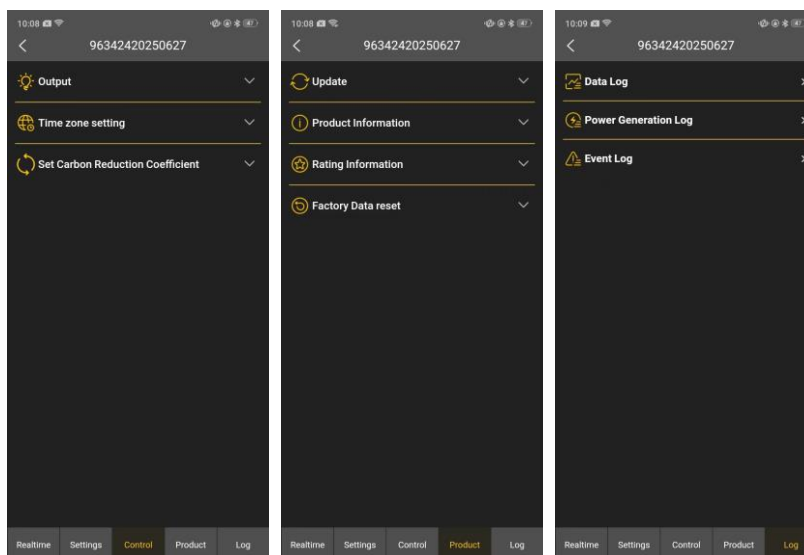

## 2-6. Plants

Click the "Plants" tab to enter plants page. User can create a power station name and add multiple devices by pressing the buttons highlighted by the red box, then view real-time data of the power station.



## 2-7. Configuration

Click the "Config" tab to enter setting screen for account management, network config, Bluetooth config, language Settings, instructions and log out. Net work config and Bluetooth config refer to Section 2-2 for details, other setting pages are shown in the screenshot below.

Account management page can change password or delete account.

Through the "Instructions" entry, you can read the instructions for use of the "i.Solar" APP.

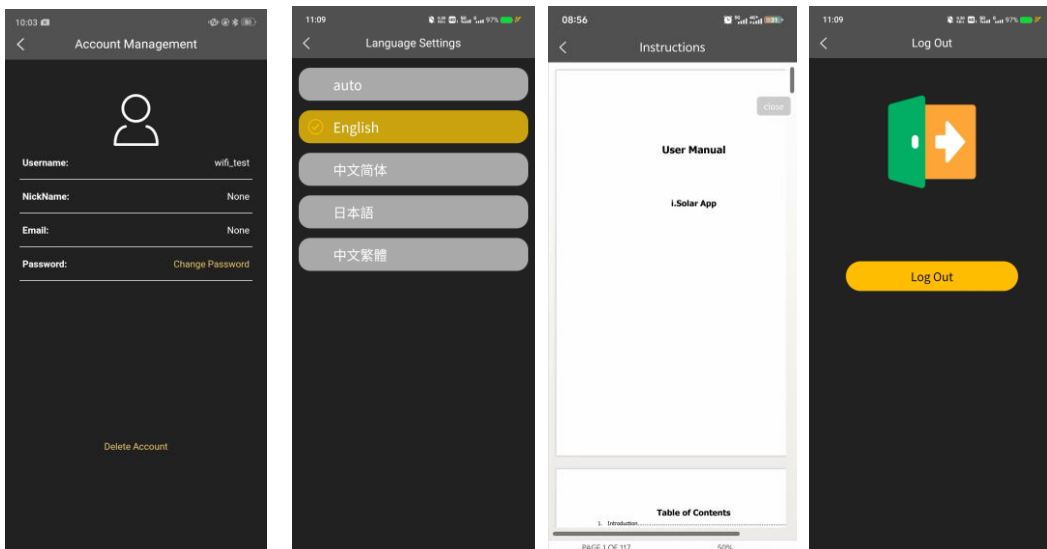
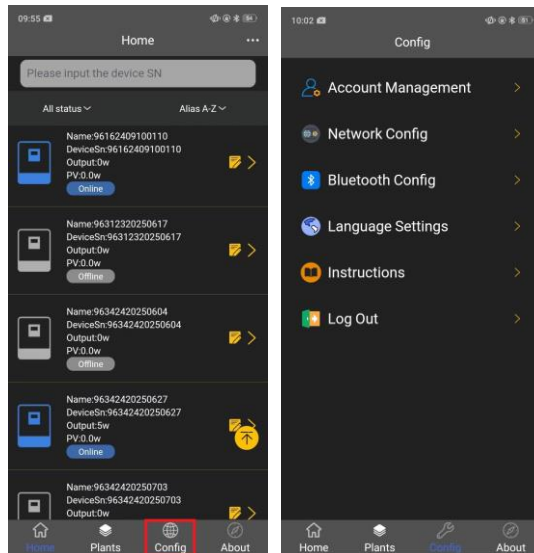

## 2-8. About

Click the 'About' tab to enter the about page, where you can view the information about the App.

